

RESIDUAL STRESS DETECTION BY MEASUREMENT OF EFFICIENCY*
OF ELECTROMAGNETIC GENERATION OF ULTRASOUND

R. Bruce Thompson
Science Center, Rockwell International
Thousand Oaks, California

I think I should thank George Matzkanin for starting everyone thinking in terms of magnetic phenomena. Yesterday we heard three papers describing the performance of electromagnetic transducers on nonmagnetic materials. The question was asked at the close of one, "Do these transducers work on ferrous materials?" The answer that I will give you is, "Yes, they do, and furthermore, the efficiency of the operation is directly related to the stress within the material." The mechanism of this relationship is very similar to the mechanism of the stress dependence of the Barkhausen effect. However, the information gained is distinct and complimentary.

The first slide (Fig. 1) will refresh your memory on electromagnetic transducers and draw the distinction between the magnetic and nonmagnetic cases. Consider a single element of the coil of an electromagnetic transducer carrying a dynamic current and placed adjacent to a metal slab. That current induces an eddy current within the slab, and if a static magnetic field is also present, there are Lorentz forces exerted on the slab which excite ultrasonic waves. This is what we heard about yesterday. In addition, there are dynamic magnetic fields circulating around the wire. These magnetic fields cause the spins in a ferrous material to slightly change their direction. From an engineering point of view one might say they cause the magnetization to be modulated about its static value. Associated with this are mechanical forces which can launch ultrasonic waves. This, then, is the magnetostrictive mechanism.

The kind of experiment we are interested in is illustrated next (Fig. 2). At the top is shown a transducer in which an electromagnet is used to produce static fields whose strength can be varied. A surface wave is excited which propagates to some fixed receiver, for example a piezoelectric wedge. If one varies the current to the electromagnet then the amplitude of the received signal in iron varies as shown below. At high fields, there is a linear relationship between the amplitude of the received signal and the applied magnetic field. This is caused by the Lorentz force generation process that is present in all metals. At lower fields one sees considerable fine structure. This is produced by the magnetostrictive contribution to the generation process. In the iron-like materials which I will mostly talk about today, there are actually two maxima in the received signal. In many other materials such as nickel, only one occurs.

I would like to first establish a little more firmly that it actually is a magnetostrictive contribution that causes this fine structure. Later I will talk about the effect of stress. In the next slide (Fig. 3), I've shown measurements of both the received ultrasonic amplitude and static magneto-

* Research sponsored by ARPA/AFML Center for Advanced NDE.

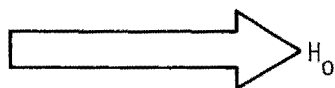
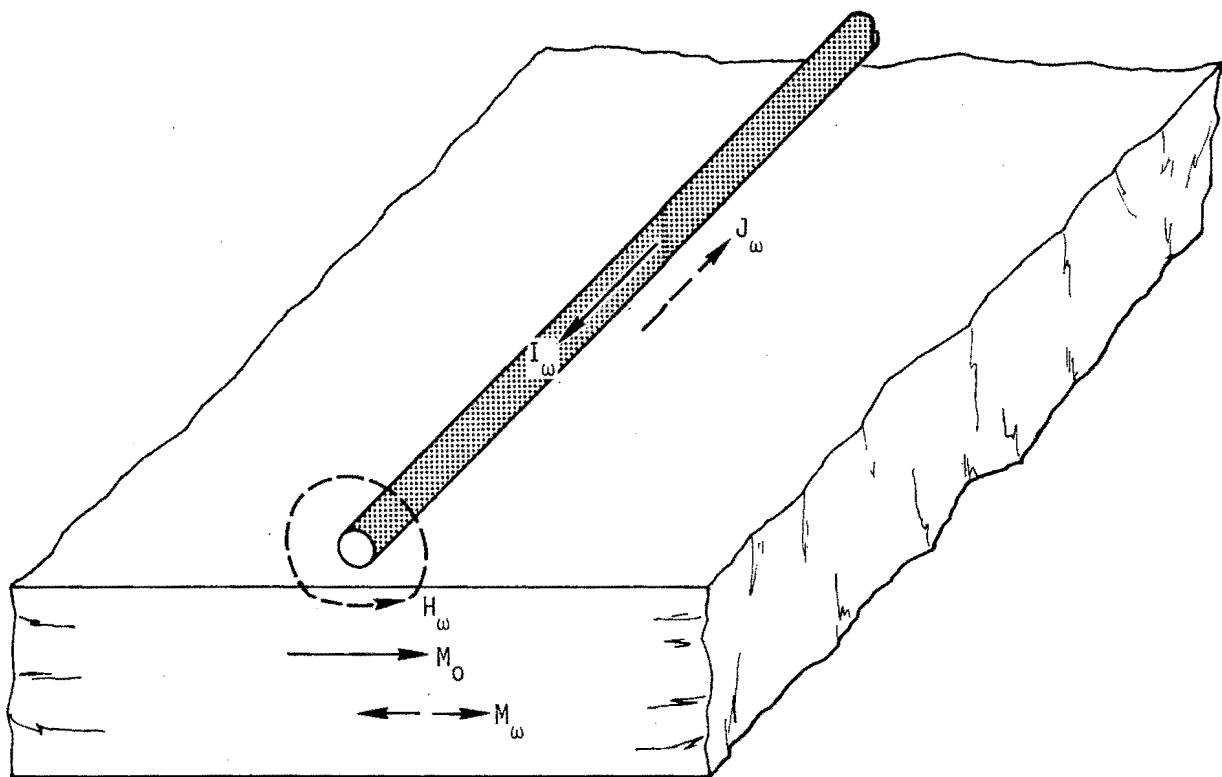

FORCE ON LATTICE:

LORENTZ FORCE

MAGNETOSTRICTION

Fig. 1. Fields and currents contributing to electromagnetic generation of ultrasound in a Ferromagnetic metal.

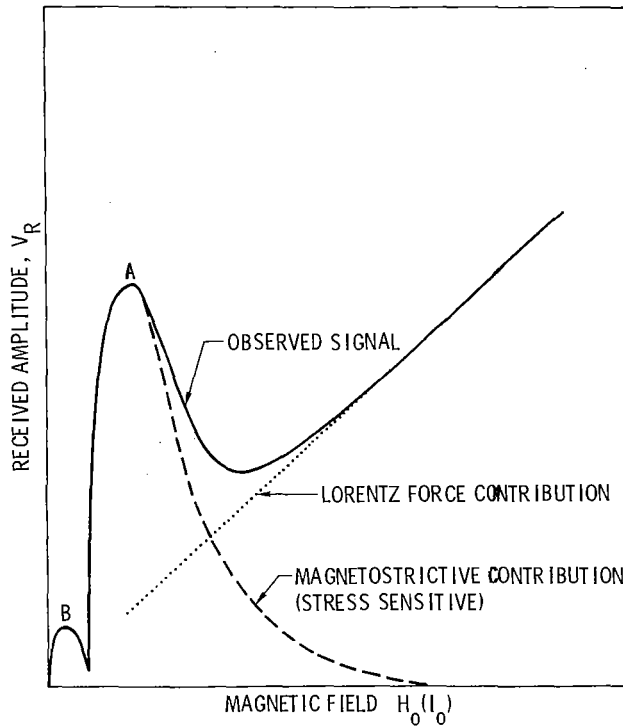
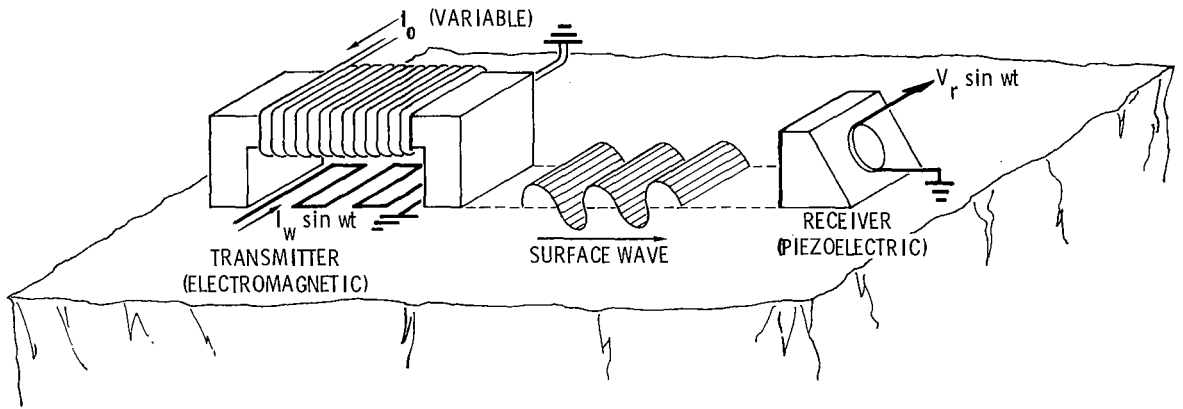

Fig. 2. Experimental configuration for measuring magnetic field dependance of electro magnetic transducer efficiency and schematic data.

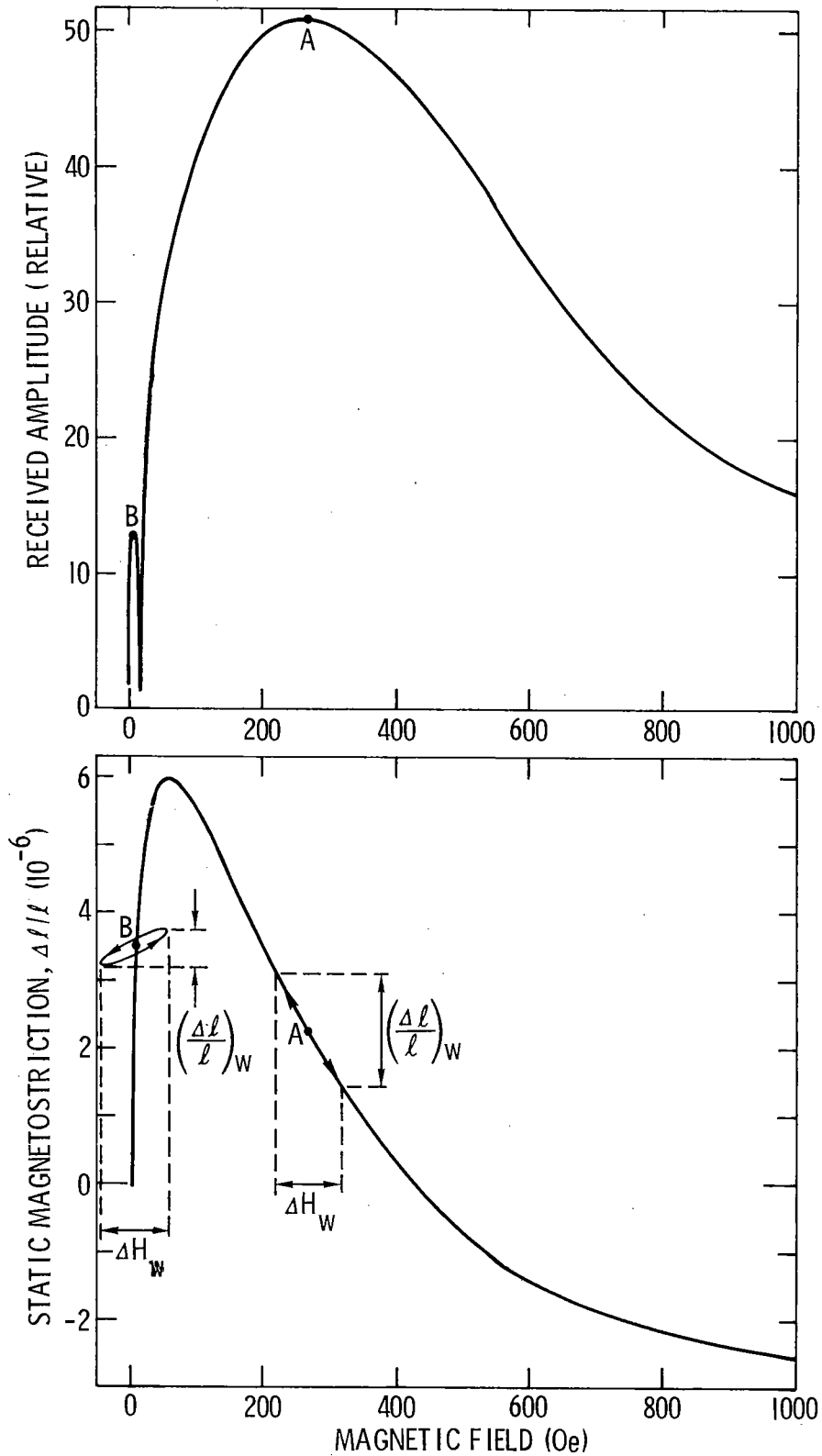

Fig. 3. Measured transducer efficiency and magnetostriction vs magnetic field in 1018 steel.

striction of the same sample as a function of magnetic field. The bottom part is rather complex, but it should be familiar to those of you who have designed amplifiers from transistor characteristics. The concept here is that a static magnetic field will produce a certain extension in some local region of the sample. If then a dynamic magnetic field is superimposed, the local region of the sample will tend to get alternately longer and shorter. At least there will be forces established that would produce such extension under equilibrium conditions. As a consequence, an ultrasonic wave will be launched whose amplitude will be proportional to the slope of this curve. From this simple-minded point of view, one expects the maximum in efficiency to occur at the point of maximum slope of the magnetostriction curve. The data obtained is in good agreement with this expectation. Efficiency Peak A occurs at a field very close to that of maximum magnetostriction slope.

You will notice that there are two maxima in the received amplitude, and that is also consistent with this model. The magnetostriction has a point of zero slope separating points of maximum positive and negative slope. Correspondingly, the received signal has two maxima separated by a sharp minima. The reversibility assumed in the above detailed discussion does not hold in the vicinity of Peak B. That is why it is not nearly so large. The reversible magnetostriction is much less than the slope of the static magnetostriction curve, and the transducer efficiency is diminished accordingly.

We have developed a quantitative model based on these concepts. It is applicable in the high field region in which domain rotation processes dominate the magnetic response. I don't have the time to go into the details of that model. Let me only say that it depends on the elastic constants and the magnetic parameters such as the anisotropy constant, of the solid. The model is compared to experiment in the next slide (Fig. 4). The only adjustable parameter in this comparison is a scalar multiplier which was adjusted to fit the experimental data in the Lorentz force regime at high fields. The model is found to quantitatively predict the magnetostrictive contribution, particularly the magnitude of Peak A. This agreement further establishes that magnetostrictive processes are responsible for the generation process.

In order to understand the stress effects, it is important to consider the origin of the peculiar magnetostriction of polycrystalline iron, which first lengthens and then shortens along the direction of an increasing field. This behavior was illustrated at the bottom of Fig. 3 and is repeated at the bottom of the next slide (Fig. 5), plotted here as a function of magnetization rather than field. This may be understood in terms of the model of Akulov¹ for iron single crystals. Consider first the case when the magnetic field is applied along the cube axis, the easy axis of magnetization. In the demagnetized state one expects a distribution of domain divided equally among the cubic axes. If one applies a magnetic field, it is assumed that the magnetization changes first by 180° reversal of the domains that are oriented antiparallel to the field. A property of magnetostriction is there is no change in length during such a process, so that magnetostriction is zero until magnetization reaches 1/3 of its saturation value. The remaining changes in magnetization are caused by displacements of 90° wall boundaries which produces the change in length² indicated at the top of the slide.

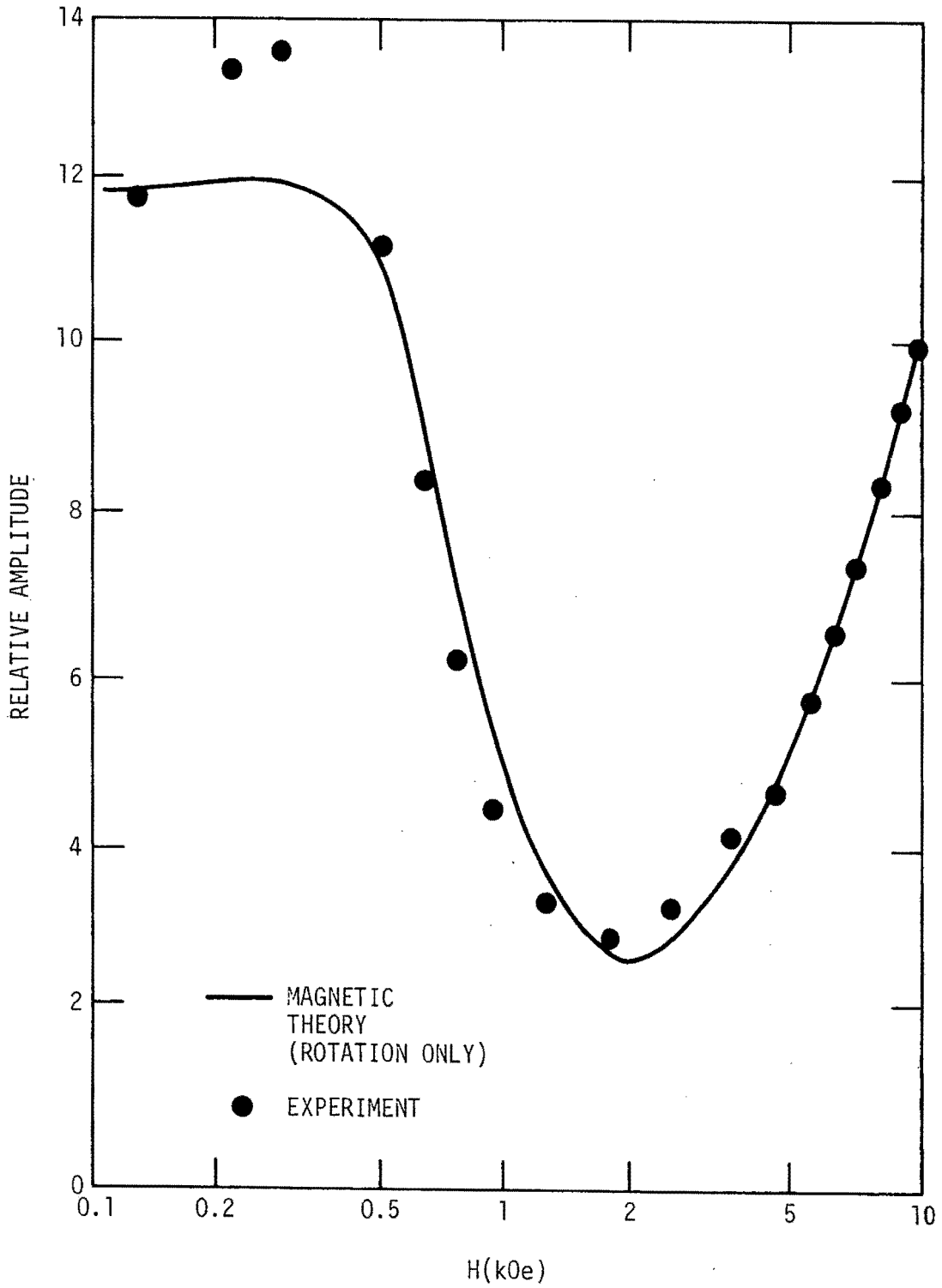

Fig. 4. Comparison of theory and experiment for generation efficiency at high fields.

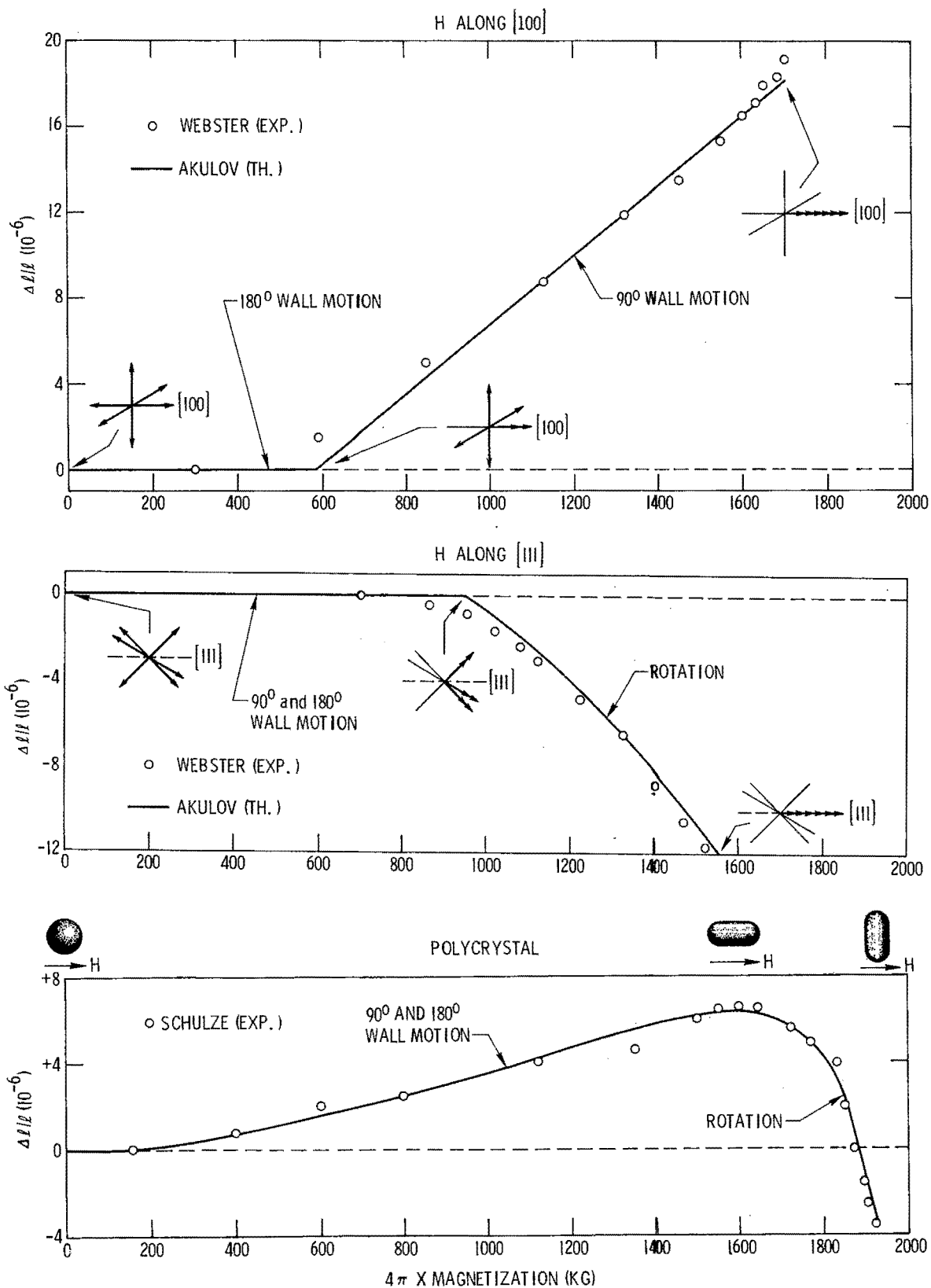

Fig. 5. Magnetostriction vs. field for iron single crystals of various orientations and for a polycrystal.

When the field is along the [111] axis, that is the body diagonal of the unit cell, one has the situation that the length of the sample is independent of the distribution of magnetization among the easy axes. Thus, no magnetostriction occurs until the 90° and 180° changes are complete and the rotational changes begin. As magnetization increases to saturation by rotation, the sample decreases in length. The large differences between the [100] and [111] behavior is a characteristic of the very anisotropic magnetostriction of iron. The fact that a polycrystal is composed of a distribution of grain orientations, including these and many others, is the cause for its peculiar behavior which includes an initial [100] like increase in length followed by a [111] like decrease in length.

Now, the reason I went through all this is so that I can answer the question "what is the effect of stress." To first order, the presence of stress does not change the [111] response. It does, however, profoundly change the [100] response and the polycrystalline behavior. This is illustrated on the next slide (Fig. 6). The top graph on the slide is the same as was shown for the [100] case on the previous slide. In addition, I have plotted the magnetic anisotropy energy. One sees minima in the energy along the cubic axes which defines these as easy axes of magnetization. As noted previously, the magnetization will be equally distributed among these directions in accordance with their equal energy.

If one applies a tension along the [100] axis, the energy of parallel or antiparallel domains is increased with respect to perpendicular domains. The magnetization then tends to align along that axis. During magnetization, changes tend to occur by the 180° reversal of domains and, in the extreme case shown, there is no magnetostriction. On the other hand, if one has compression along the [100] axis, just the opposite happens. Magnetization is initially perpendicular to the direction of the field. For sufficiently large stress, all magnetization changes are produced by 90° wall motion and there is a large positive magnetostriction.

These results illustrate a rather significant stress dependence of the magnetostriction for the [100] axis case. In a polycrystal, corresponding effects also occur (Fig. 7). Just as the unstressed polycrystalline response could be explained qualitatively in terms of the [100] and [111] cases, so can the stressed response. When a tensile stress is applied, the positive magnetostriction of the [100] grains is suppressed, and so is the initial increase in length of the polycrystal. Conversely, when a compressive stress is applied, both of these effects are enhanced.

Returning to the measurements of transducer efficiency, recall that it was closely related to the slope of the magnetostriction curve. From Fig. 7, it seems clear that major differences could be expected in tension or compression.

The experiment that has just been completed is to measure the stress dependence of generation efficiency. The apparatus is shown in the next slide (Fig. 8). A sample is placed in a 4 point bending apparatus so that one side of the sample is in tension, and the other side in compression. An electromagnetic transducer is used to launch a wave which is picked up by a

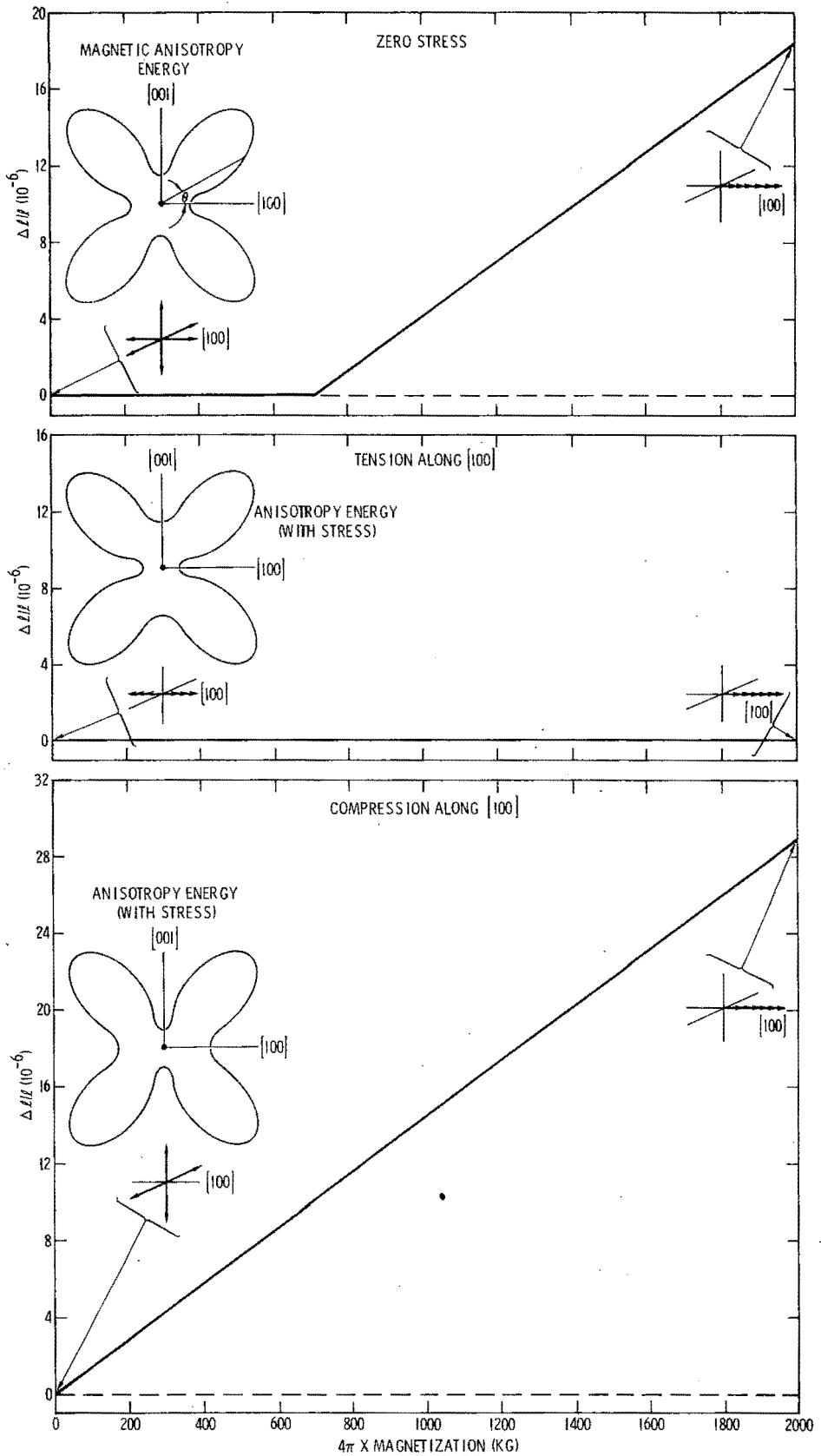

Fig. 6. Stress dependence of magnetostriction of iron crystal when both magnetic field and stress are along [100] Axis.

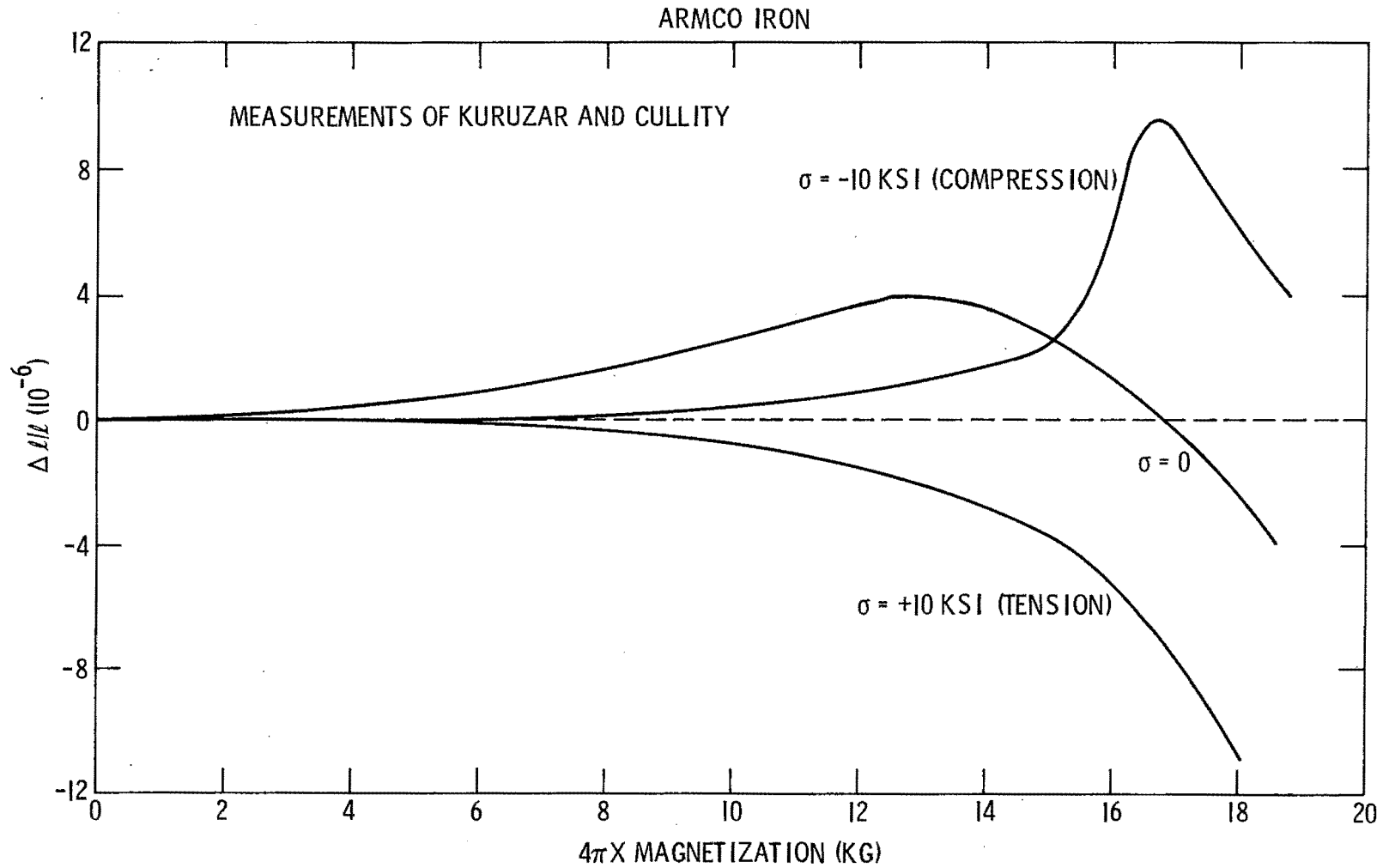

Fig. 7. Stress dependence of magnetostriction of polycrystalline iron.

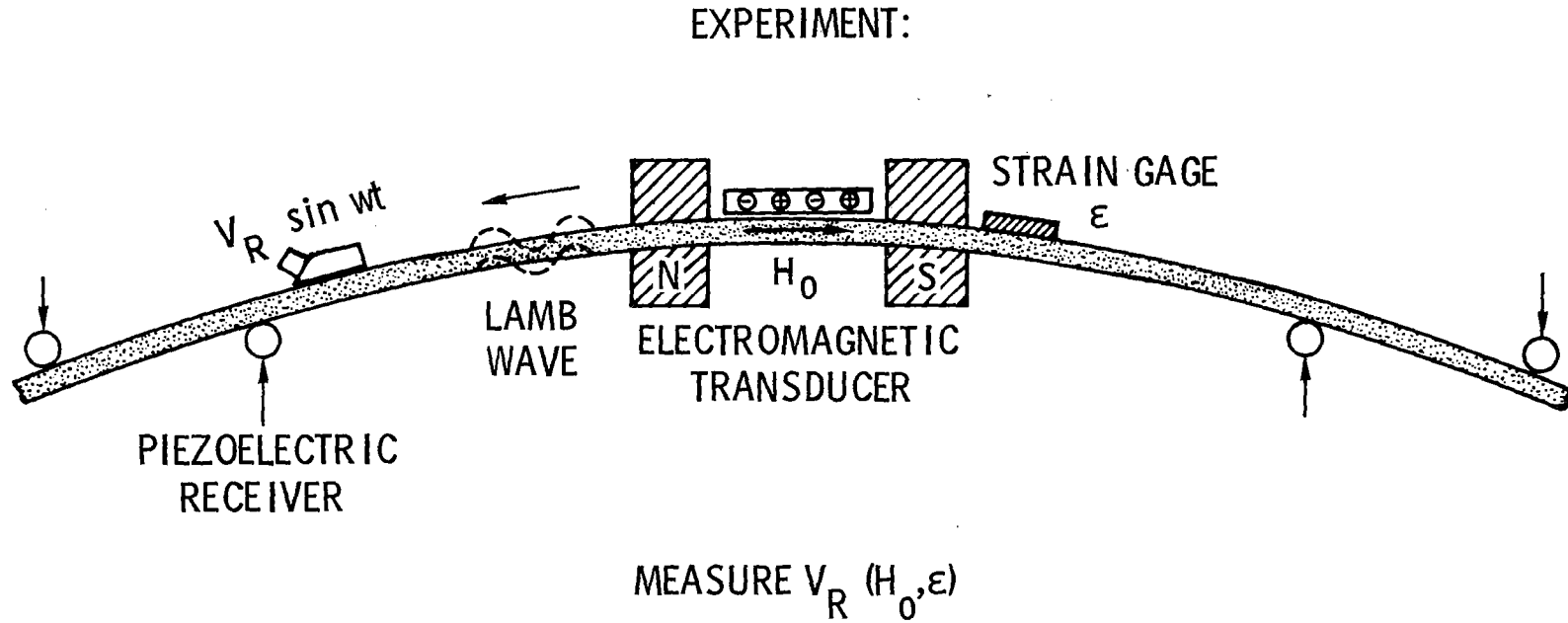

Fig. 8. Experimental apparatus for measuring stress dependence of transducer efficiency.

piezoelectric wedge. The amplitude of the received signal is measured as a function of the strain in the sample and, of course, of the magnetic field.

Some typical data that we obtained is shown in the next slide (Fig. 9). This is the low field behavior, in the vicinity of the smaller peak that was shown in Fig. 3 and which occurs at fields on the order of 10 Oersts. For zero applied stress, the solid curve with a sharp peak is observed. For a tensile load, this peak vanishes and, furthermore, the rapidly increasing portion of the curve moves to lower fields. Conversely, for a compressive stress, this rapidly increasing portion of the curve moves out to higher fields and as you can see, considerably different peak structure occurs.

Now, we are just beginning on this work, and it is premature to try to specify an optimum testing procedure based on the phenomena. However, it is fair to ask the question, "what might be a simple thing to measure which would yield useful information?" The next slide which I will show you will illustrate one example, the stress induced change in the steep portion of the curve. I am not saying that is the only thing one wants to measure. I am saying that is an obvious feature to look at initially. There is a lot more information, but we are not ready to unravel it all at this time.

We did an experiment which is illustrated at the top of the next slide (Fig. 10). It was chosen because it is simple and could easily be performed by an operator or an automatic instrument. The magnetic field was decreased from a high value until the first peak denoted by A was passed and then on until the signal dropped to a third of the peak A value. The electro-magnet voltage required to produce this 1/3 amplitude signal is a very well defined experimental parameter. The value of that voltage is plotted in the lower part of the slide as a function of strain as measured by resistance strain gages bonded directly to the sample. By combining the data obtained on both sides of the sample, the full elastic range of tensile and compressive stresses was investigated. The change of V 1/3 from 1 to 6 volts is a very large effect, and hence, the technique shows promise of high sensitivity. Saturation effects were observed on both the compression and tension sides. This is less serious in the compression case, where the sensitivity remains high up to calculated stresses of -60 KSI. This would thus appear to be ideally suited for the inspection of surfaces prepared by shot peening or other techniques intended to induce a compressive stress.

As you may have noticed, there is an offset between the data obtained on the two sides of the sample. We found this very intriguing and wanted an independent measurement to determine whether there was a real difference in the stress in the sides. We took our samples down to the Northrop Aircraft Division in Hawthorne and were kindly helped by their personnel, under the direction of R. E. Herfert. They used the fast stress X-ray unit, originally developed at GM, to determine the stress on both sides of the sample. An offset of 13 KSI was found, in good agreement with the 17 KSI offset in our data. We found this substantiation of our prediction very gratifying.

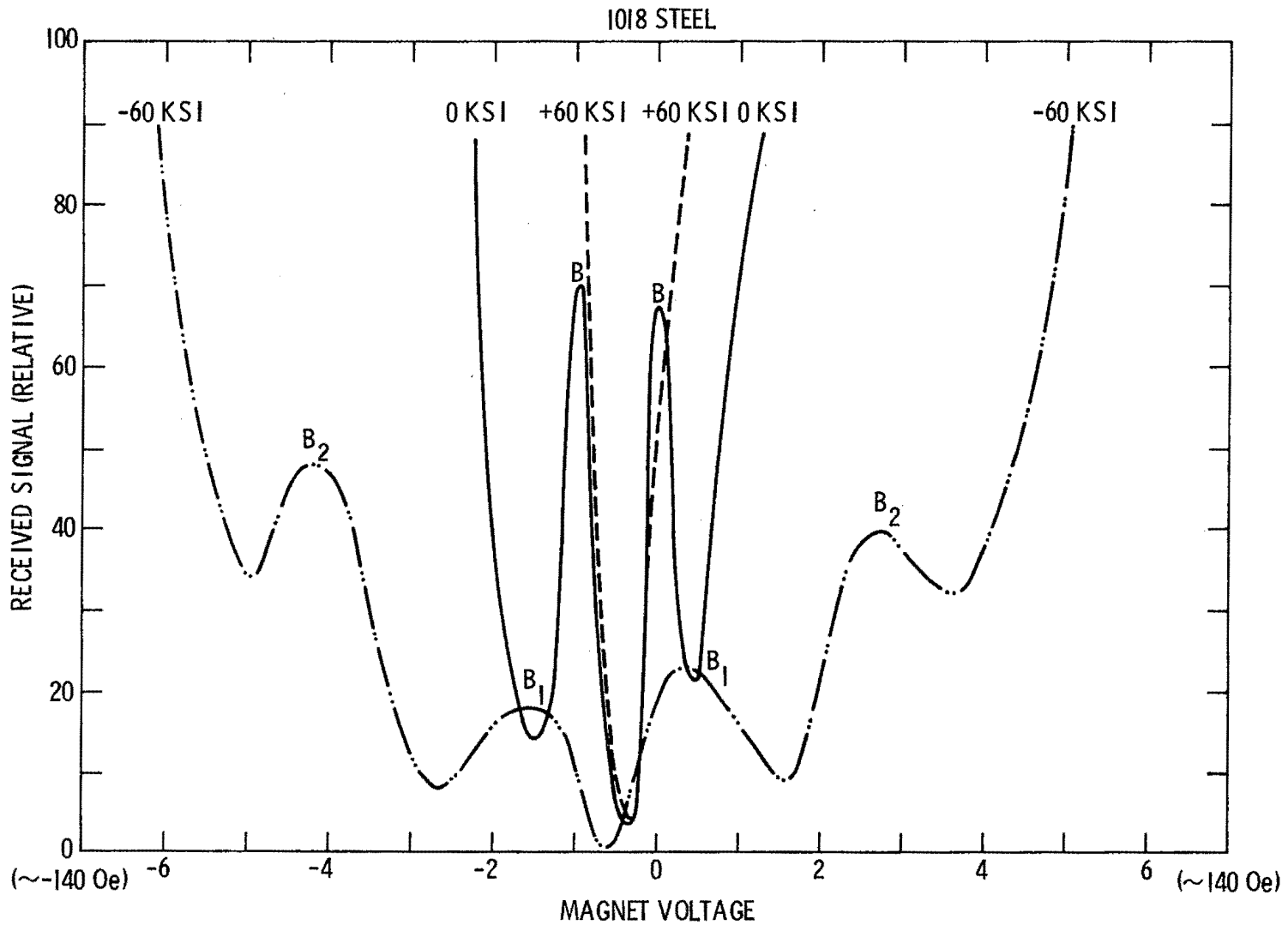

Fig. 9. Transducer efficiency versus magnetic field (volts) for tensile and compressive stresses.

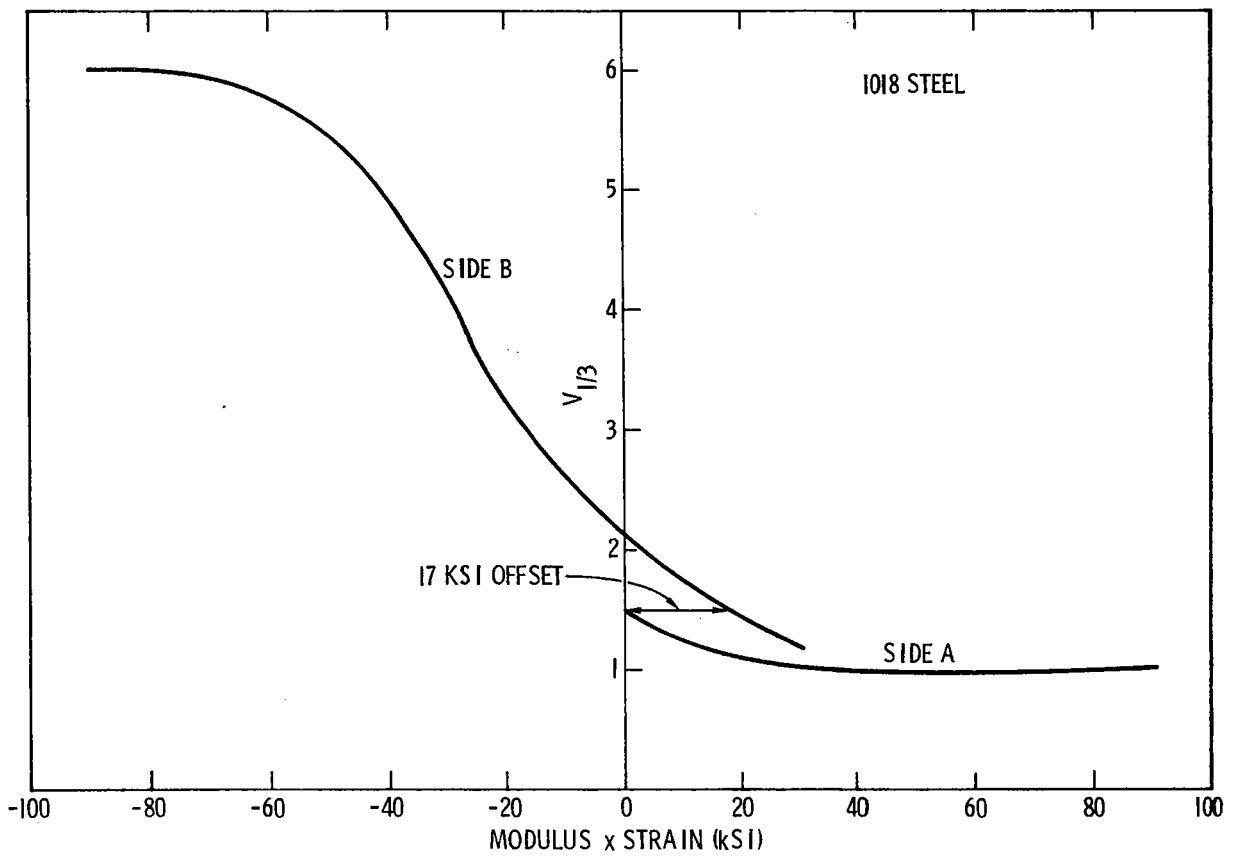
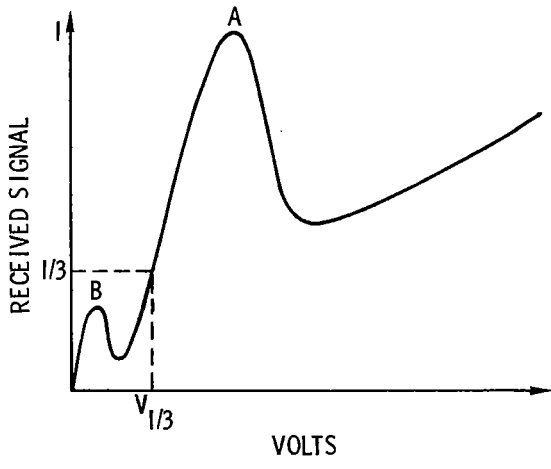

Fig. 10. Variation of $V_{1/3}$ with stress.

A few of the characteristics of this technique for stress detection are as follows:

Simple Apparatus
Non-Contact Operation
Insensitive to Paint, Surface Finish
Surface Measurement (Electromagnetic
Skin Depth)

It is certainly premature to say these are the characteristics of a finished device. On the other hand, it is important to imagine what the end result would be if future work's equally promising. It is obvious that the technique requires a simple apparatus. It operates in non-contact fashion. It should be insensitive to paint, surface finish and so forth. It senses stress in a layer near the surface of thickness equal to the electromagnetic skin depth. In our experiments at 160 KHz, this was several mils.

In conclusion, it would be useful to make a comparison between this technique and the Barkhausen approach described in the previous papers. There are several differences and I think these should be explored in the future. For example, the Barkhausen effect is produced primarily by 180-degree walls motion. Our effect is sensitive to 90-degree wall motion. The Barkhausen effect essentially measures the characteristics of the static magnetization process. We are making a measurement which has to do with cyclic changes in the magnetic state of the sample. It is clear to me that these are complementary pieces of information, and I think a combined study of these and other magnetic properties could be quite fruitful.

Thank you.

References

1. N. Akulov, Z. Physik 69, 78-99 (1931).
2. W. L. Webster, Proc. Roy. Soc. (London) 107A, 496-509 (1925).
3. Michael E. Kuruzar and B. D. Cullity, Intern. J. Magnetism 1, 323-325 (1971).

DISCUSSION

DR. WALKER: Thank you very much. Are there any questions?

MR. MIKE STELLABOTTE (Naval Air Development Center): Your experimental apparatus showed the electromagnetic transducer on the tension side of the specimen. Would you expect any differences were it on the compression side?

DR. BRUCE THOMPSON: Oh yes, that was on this slide (return to Fig. 8). If you recall, since we went into the region of plastic flow, we made measurements with the transducer on both sides of the sample for each incremental increase in deformation. The two curves marked +60 KSI on the next slide (Fig. 9) correspond to the two positions. That was the origin of the difference in the data in Side A and side B.

PROF. HARRY TIERSTEN (Rensselaer Polytechnical Institute): You have been talking about measuring residual stress. Are you measuring residual stress or strain? Would you care to comment on that?

DR. BRUCE THOMPSON: I would prefer to say that I am measuring strain. I think that would be my taste. That is a good question which deserves a lot of consideration. Stress is the term usually used for such measurements and I conform with that convention.

DR. YIH PAO (Cornell University): I was wondering, have you counted the Kelvin's force, which is the $\vec{M} \cdot \vec{v}$ term, in your calculation?

DR. BRUCE THOMPSON: I do not believe I have, no.

DR. PAO: That could be very big. You see, you have induced a line current which has a large gradient. The Kelvin's force, equal to the $\vec{M} \cdot \vec{v}$ of it, could be a very large force in your case.

DR. BRUCE THOMPSON: Perhaps we should talk about that. I would like that.

DR. WALKER: Any other questions?

A question here?

MR. BOB ERWIN (Northrop Corporation): Have you a practical input for problems of liftoff? For example, you mentioned something at the end of a characteristic list.

DR. BRUCE THOMPSON: Yes. Basically, our experiment is calibrated against liftoff in the sense that we measure the field dependence of the transducer efficiency. I would expect the liftoff to change the amplitude at all fields proportionately. In other words, we can compare our data at some low field value to the data, say, at a high maximum efficiency point. Both of those are decreased by liftoff. I believe, at least in the first order, they are decreased proportionately. So, I don't think liftoff is a serious problem. Of course, if the liftoff is too far you don't get any signals. The half signal distance is 100 mils at our

particular operating frequency of 130 KHz: if you lifted the transducer 100 mils, the signal would only go down by a half. You should be closer than that.

- MR. ERWIN: The characteristics of the curve would be the same?
- DR. BRUCE THOMPSON: I have not measured that, but based on my concept of what is going on, I think it would.
- DR. HAROLD FROST (AFCL): What was the operating frequency of the transducer?
- DR. BRUCE THOMPSON: I just told him 130 KHz but I realize that was wrong. It was actually 165 KHz in the particular measurement. As you know, we have a lot of transducers that work at that frequency. This convenience was the primary reason for that selection.
- DR. WALKER: Any other questions?
- DR. SY FRIEDMAN (NSRD, Annapolis): At this state of magnetization of the specimen the depth of penetration of eddy currents is known to be quite dependent on the permeability of the material. In this case, you would sort of have a small signal permeability that would depend on where you are in the hysteresis loop.
- DR. BRUCE THOMPSON: That's correct.
- DR. FRIEDMAN: Since you are varying it, I don't know how the permeability in one direction would be affected by changing the magnetization orthogonal to it. But the effective permeability that the currents see, if you will, is something I think you have to know or control to make sure it stays the same from measurement to measurement.
- Did you consider that?
- DR. BRUCE THOMPSON: Well, certainly you are changing the permeability. The instrumental response is a function not just of the magnetostriction, but also of the permeability. I agree 100 percent with that and in the model that certainly is included. The dominant effect that causes the feature we see is the magnetostriction changes, but certainly the permeability changes are also important.
- DR. CRAIG BIDDLE (Pratt/Whitney Aircraft): Referring to what he is talking about, could you then saturate with a permanent magnet the permeability in the same way you do with eddy currents? You could now make that a constant and proceed to measure your stress?
- DR. BRUCE THOMPSON: No, unfortunately not, because you would also saturate your magnetostriction.

DR. BIDDLE: So this would depend on the use of a material that does not have variable permeability across its surface as many materials do?

DR. BRUCE THOMPSON: Well, certainly, the permeability does play a role in the measurement. What I might suggest is that the permeability plays a very simple role in my theoretical idea of what is going on. You could measure this independently with an eddy current instrument and compensate the measurements if necessary.

The real question is how do the mechanisms that cause the change in permeability affect the magnetostriction? What other processes might change magnetostriction that we did not investigate in these experiments. Obviously we have to look at texture effects, the kinds of effects that the Southwest Research work on the Barkhausen effect was addressing.

DR. WALKER: Any other questions?

I would like to thank the speakers for this afternoon's session and for the fine papers we heard, and also you, the audience, for your tenacity in sticking it out.

I'd like to make one observation with respect to the flat bottom hole. If you can include some of the considerations we have seen this afternoon, you have got years of work and with that I will turn this session back over to Don Thompson.