

COMPARISON OF DIRECT VS. INDIRECT VENTILATION RATE DETERMINATIONS IN LAYER BARNS USING MANURE BELTS

H. Li, H. Xin, Y. Liang, R. S. Gates, E. F. Wheeler, A. J. Heber

ABSTRACT. Direct measurement of building ventilation rate in livestock housing is a formidable task due to uncontrollable variations in fan and system performance that are caused by factors such as building static pressure, fan belt slippage, and dust accumulation on shutters and blades. Estimating building ventilation rate by an indirect method based on a CO₂ balance offers a potentially viable alternative to direct measurement. The validity of the CO₂ balance method depends on the validity of relationship between CO₂ production inside the building and metabolic rate of the animals and the knowledge of CO₂ generation by the housing environment. Metabolic rates of modern laying hens have recently been quantified in intensive large-scale laboratory measurements. However, performance of the indirect method remains to be evaluated under field conditions. This article compares building ventilation rates obtained by direct measurement and by a CO₂ balance. The test was conducted at a commercial laying hen house that used manure belts with daily manure removal. The results indicate that ventilation rates estimated by the indirect method were not significantly different ($P > 0.2$) from those as determined by the direct measurement when the averaging or integration time interval was 2 h or longer. Careful application of the indirect method could greatly improve the affordability and versatility of endeavors toward quantifying air emissions from confined animal housing.

Keywords. Air emissions, Building ventilation rate, CO₂ balance, Laying hen.

Air quality associated with animal feeding operations (AFOs) or concentrated animal feeding operations (CAFOs) remains a pressing issue for both the animal industry and academic communities. The need to quantify air emissions from AFOs/CAFOs with relative ease and reasonable certainty continues to rise. Ventilation rate through an emission source is one of the two essential elements for quantifying emission rates, with the other element being concentration of the substance in question. Ventilation rate is generally more complex and less certain to obtain than concentration.

Two primary techniques exist for determining the ventilation rate of an animal confinement building: direct and indirect measurement. Direct measurement, applicable to mechanically ventilated buildings, involves determination of

the airflow rate of the exhaust or supply fans at a certain static pressure and with a certain number of fans in operation. The airflow rate of each fan may be estimated based on manufacturer-supplied fan performance curves. However, such estimation is prone to considerable error (e.g., 10% to 25%) due to altered fan curves arising from uncontrollable variables in the field, such as loose fan belts, partially open and dirty shutters, and dirty fan blades. Alternatively and preferably, a fan may be calibrated *in situ* to reflect the actual operating conditions in the field. In the past, velocity traverse of the fan airflow stream involving limited measurement points (e.g., 16 to 25) has been used to accomplish this. Recently, a more sophisticated tool, known as the Fan Assessment Numeration System (FANS), was developed and is increasingly used to improve *in situ* measurement certainty of fan airflow capacity (Simmons et al., 1998; Gates et al., 2004; Wheeler et al., 2002). Even with the FANS, challenges still exist in that certain types of confinement housing (e.g., cross-ventilated laying hen houses) have a large number of ventilation fans (e.g., 40 to 70 per house), making it formidable to calibrate all the fans. Furthermore, the *in situ* fan curves may vary over the course of long-term monitoring due to outside wind speed/direction or conditions of the fan itself.

Indirect ventilation measurement techniques involve use of a tracer gas in the ventilated building or space and monitoring the decay rate to indirectly determine the ventilation rates. The basic principle of the tracer technique is to release a known amount of tracer, monitor its concentration at downwind points, and use the decay rate of the tracer gas concentration to calculate the air exchange rate. The application of this method is often limited because it requires uniform air-tracer mixing to ensure good results, which is difficult to achieve under commercial production settings. Based on the ideal characteristics of a released tracer (including low and stable background level, non-hazard,

Article was submitted for review in July 2004; approved for publication by the Structures & Environment Division of ASAE in November 2004.

Mention of vendor or product names is for presentation clarity and does not imply endorsement by the authors or their institutions, or exclusion of other suitable products.

The authors are **Hong Li, ASAE Student Member**, Graduate Research Assistant, **Hongwei Xin, ASAE Member Engineer**, Professor, and **Yi Liang, ASAE Member Engineer**, Post-Doctoral Research Associate, Department of Agricultural and Biosystems Engineering Department, Iowa State University, Ames, Iowa; **Richard S. Gates, ASAE Member Engineer**, Professor and Department Chair, Department of Biosystems and Agricultural Engineering, University of Kentucky, Lexington, Kentucky; **Eileen F. Wheeler, ASAE Member Engineer**, Associate Professor, Department of Agricultural and Biological Engineering, Pennsylvania State University, University Park, Pennsylvania; and **Albert J. Heber, ASAE Member Engineer**, Professor, Department of Agricultural and Biological Engineering, Purdue University, West Lafayette, Indiana. **Corresponding author:** Hongwei Xin, Department of Agricultural and Biosystems Engineering, 3204 NSRIC, Iowa State University, Ames, IA; 50011-3310; phone: 515-294-4240; fax: 515-494-4250; e-mail: hxin@iastate.edu.

acceptability, ease of measurement, stability, and low cost), carbon monoxide, helium, and sulfur hexafluoride (SF₆) have been used in livestock-related cases (Phillips et al., 2000, 2001). In addition to releasable tracers, metabolic carbon dioxide (CO₂) is available in livestock buildings as a tracer (Feddes et al., 1984; Van Ouwerkerk and Pedersen, 1994). Naturally, the validity of the CO₂ balance method depends on the reliability of the metabolic rate data of the animals. Metabolic rates of modern pullets and laying hens (Hy-Line W-36 breed, the most popular U.S. commercial strain) have recently been quantified in large-scale indirect calorimetry measurements (Chepete et al., 2004; Chepete and Xin, 2004). However, the accuracy of the indirect method remains to be evaluated under field production conditions where CO₂ contribution from manure decomposition may contribute to CO₂ generation and thus to the determination of building ventilation rate.

The objective of this article was to compare the building ventilation rates of a commercial laying hen house, featuring manure belts and daily manure removal, as obtained from direct measurement based on *in situ* fan performance and run time vs. indirect determination based on a CO₂ balance.

MATERIALS AND METHODS

LAYER HOUSE AND MANAGEMENT

A manure belt laying hen house owned by a cooperative egg producer located in north central Iowa was used for the study. The layer house had an east-west orientation and a dimension of 18 m (61 ft) wide by 159 m (522 ft) long. It used a quasi-tunnel ventilation system that consisted of thirteen 1.2 m (48 in.) diameter exhaust fans and two 0.9 m (36 in.) diameter exhaust fans in each end wall and two rows of continuous slot ceiling inlets (4.5 m or 15 ft interior from each

sidewall) controlled by static pressure set at 17 Pa (0.07 in. H₂O) (fig. 1). The ventilation fans were cleaned weekly with compressed air. Exhaust fans at each end were grouped in pairs that were controlled, in eight stages, according to the mean house temperature near the middle of the house. One (minimum ventilation fan) of the 0.9 m fans at each end operated continuously. The battery cages were arranged in eight cage rows with three tiers per cage row. Bird feces fell directly onto the belt underneath the cages and were removed from the house each morning. There was an 18 m (61 ft) open space between adjacent buildings. At the onset of the monitoring study in March 2003, there were 98,000 Hy-Line W-36 hens at 104 weeks of age. A replacement flock of 100,000 W-36 hens at 20 weeks of age was introduced into the house in July 2003. Photoperiod remained 16L:8D during the monitoring period for the first flock, but it started at 12L:12D and was increased by 30 min per week until it reached 16L:8D for the replacement flock. *Ad-lib* feed and water were provided, and standard commercial egg industry diets were used (table 1).

MEASUREMENT INSTRUMENTS AND DATA ACQUISITION

Portable monitoring units (PMUs), as described by Xin et al. (2002), were used to continuously collect CO₂ concentration of incoming and exhaust air (fig. 2). One PMU was mounted on each end wall of the house. Inside the PMU, a programmable on/off timer was used to operate a 3-way solenoid valve that in turn controlled the switching between incoming fresh air and exhaust air. The incoming air was sampled from the attic space, and the exhaust air was a composite sample from four aisle locations at each end about 5 m (15 ft) from the exhaust fans (fig. 1). Due to the operational characteristics of the electro-chemical ammonia sensors used in the PMU, 8 min sampling of the exhaust air followed by a 22 min purging with incoming air was used throughout the measurement episodes. Carbon dioxide con-

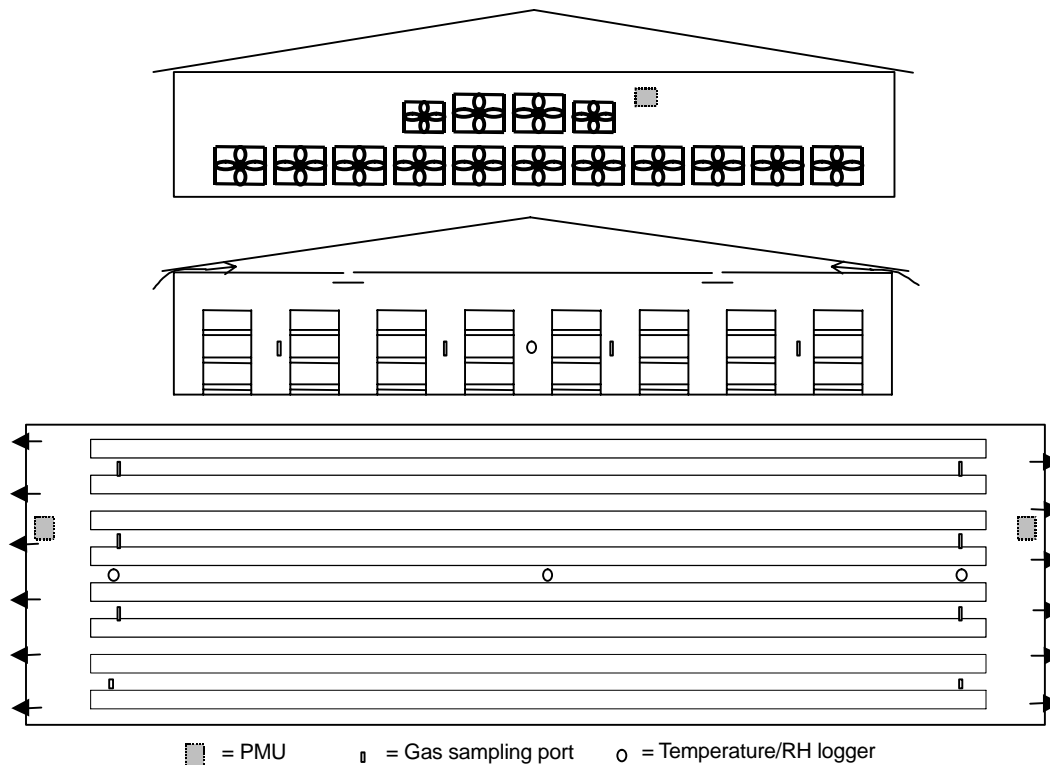

Figure 1. Schematic of the manure-belt layer house showing the end wall, cross-section, and floor plan of the house and the sampling locations.

Table 1. Dietary ingredients of feed used in the field study (% , unless otherwise noted).

Dietary content	Bird Age (weeks)		
	21 – 36	37 – 63	>64
ME (MJ kg ⁻¹)	11.80	11.60	12.20
Crude protein	18.00	14.82	15.80
Crude fat	N/A	2.77	N/A
Crude fiber	N/A	2.37	N/A
Calcium	4.25	4.42	4.12
Total phosphorus	0.76	0.47	N/A
Available phosphorus	0.57	N/A	0.31
Sodium	0.21	0.21	0.18
Total lysine	N/A	0.80	N/A
Lysine	1.03	N/A	0.82
Methionine	0.51	N/A	0.36
Total methionine	N/A	N/A	N/A
Methionine and cystine	N/A	0.61	N/A
Choline (mg kg ⁻¹)	N/A	N/A	1141

centration was monitored with an infrared CO₂ transmitter (0 to 7000 ppm ±20 ppm, model GMT222, Vaisala, Inc., Woburn, Mass.). The output of the transmitter (4 to 20 mA) was recorded with a 4-channel battery-operated data logger (4 to 20 mA ±0.1%, Onset Computer Corp., Bourne, Mass.). Static pressures of the building were monitored at both ends (4 to 20 mA ±1% for 0 to 125 Pa or 0 to 0.5 in. H₂O, model 262, Stage, Inc., Pittsburgh, Pa.) and recorded with the same 4-channel data loggers. Temperature and RH at each end, about 5 m from the exhaust fans, and in the middle of the house were recorded with portable temperature/RH loggers (0°C to 50°C ±3%, HOBO Pro RH/Temp, Onset Computer Corp.). Runtime of the 14 paired exhaust fans (except the minimum, continuous ventilation fan) at each end was monitored with on/off motor loggers (HOBO on/off motor, Onset Computer Corp.) that were attached to the power lines for individual fans. Outside temperature and RH were also measured with the same type of temperature/RH loggers as used inside the barn.

The semi-hourly average or instantaneous readings of CO₂ concentrations, static pressure, air temperature, and fan run time were calculated and analyzed. Data collection was conducted every two weeks during the 8-month monitoring period. Each collection episode consisted of 48 h or longer continuous measurements.

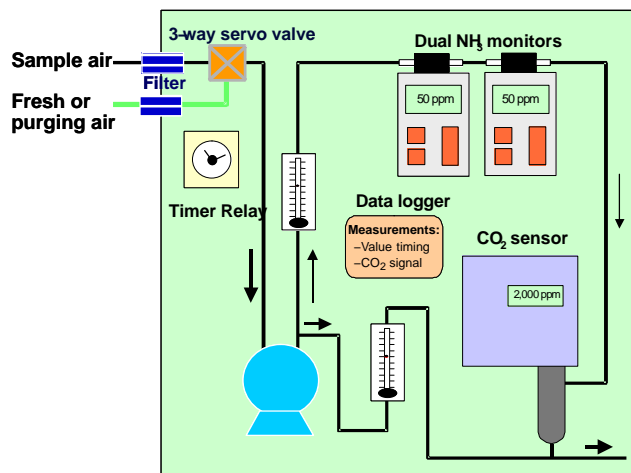

Figure 2. Schematic of the portable monitoring unit (PMU) used in the field measurement of CO₂ and NH₃ concentrations.

DIRECT MEASUREMENT OF BUILDING VENTILATION RATE

A FANS unit (Casey et al., 2004; Gates et al., 2004) was used to individually calibrate the airflow of all the exhaust fans of the layer house. With a hydraulic lift cart and plywood platform for easy height adjustment, the FANS unit was placed upstream against the exhaust fan to be calibrated (fig. 3). Space gaps between the fan/wall and the FANS were carefully sealed with foam insulation board and adhesive (duct) tape. Because the house normally operated at static pressure of 15 to 25 Pa (0.06 to 0.10 in. H₂O), airflow rates of the exhaust fans were evaluated at the static pressure levels of 0, 12.5, 25, and 40 Pa (0.0, 0.05, 0.10, and 0.16 in. H₂O). Each tested static pressure was achieved by adjusting the inlet opening through the inlet controller. Once the static pressure was stabilized, the FANS unit was run twice (up and down), with each run taking about 3 min. If the difference between the two runs was less than 2%, the result was considered acceptable and the average was taken as the data point. An inclined manometer (-12.5 to 62.3 Pa or -0.05 to 0.25 in. H₂O) was also used to provide instantaneous static pressure readings. To eliminate the effect of airflow reduction when a fan operates with its stage members versus alone, measurements of the individual fans were conducted under their actual combinations of operation with other exhaust fans. Individual fan performance curves were then developed for all the exhaust fans. Subsequently, airflow through each fan was calculated with the actual static pressure measured by the static pressure transducer. Summation of the individual airflows at a given time yielded the instant ventilation rate of the layer house. The ventilation fans were checked again using FANS near the end of the monitoring period, and the results revealed little change in their performance.

INDIRECT DETERMINATION OF BUILDING VENTILATION RATE BY CO₂ BALANCE

The CO₂ balance method is based on the principle of indirect animal calorimetry. Namely, metabolic heat production of non-ruminants is related to oxygen (O₂) consumption and CO₂ production of the animals in the following form (Brouwer, 1965):

$$THP = 16.18O_2 + 5.02CO_2 \quad (1)$$

where

THP = total heat production rate of the animal (W kg⁻¹)

O₂ = oxygen consumption rate (mL s⁻¹ kg⁻¹)

CO₂ = carbon dioxide production rate (mL s⁻¹ kg⁻¹)

The ratio of CO₂ production and O₂ consumption is defined as the respiratory quotient (RQ) of the animal, i.e.:

$$RQ = CO_2/O_2 \quad (2)$$

Substituting equation 2 into equation 1 gives:

$$CO_2 = \frac{THP}{\frac{16.18}{RQ} + 5.02} \quad (3)$$

The CO₂ production rate also can be related to building ventilation rate (V, m³ h⁻¹ kg⁻¹) as follows:

$$V = \frac{CO_2 \text{ production} \times 10^6}{[CO_2]_e - [CO_2]_i} \quad (4)$$

where [CO₂]_e and [CO₂]_i are the CO₂ concentrations (ppm) of exhaust and incoming air, respectively.

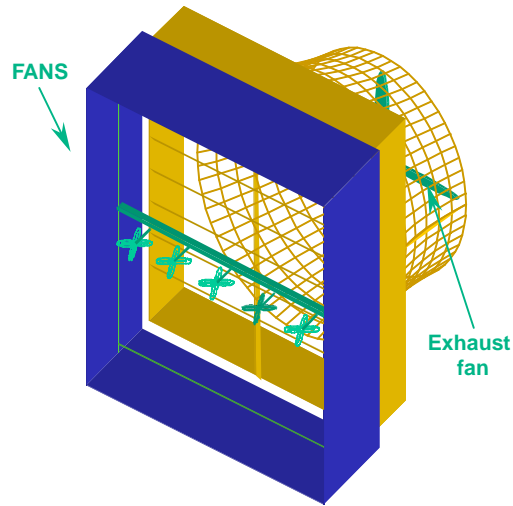

Figure 3. Snapshot of *in situ* calibration of airflow rate of exhaust fans in the monitored layer house using the FANS unit.

Hourly THP and RQ of W-36 breed laying hens during light and dark periods of the day, as reported by Chepete et al. (2004) and Chepete and Xin (2004), were used to estimate CO₂ production of the hens using equation 3. THP ranged from 5.6 to 7.8 W kg⁻¹, depending on light or dark period, and the RQ ranged from 0.85 to 0.99.

RESULTS AND DISCUSSION

VENTILATION RATE BY DIRECT MEASUREMENT

A total of 28 exhaust fans (24 1.2-m fans and four 0.9-m fans) were calibrated and their performance curves were established (the remaining two 1.2 m fans were out of order). Considerable variation existed in fan performance (fig. 4). For instance, airflow rate at 0 Pa static pressure varied from 11,560 to 15,300 m³ h⁻¹ (6,800 to 9000 cfm) for the four 0.9 m fans and from 23,460 to 28,050 m³ h⁻¹ (13,800 to 16,500 cfm) for the twenty-four 1.2 m fans. At 40 Pa (0.16 in. H₂O) static pressure, airflow rate varied from 2,060 to 5,678 m³ h⁻¹ (1,212 to 3,340 cfm) and from 0 to 18,734 m³ h⁻¹ (0 to 11,020 cfm) for the 0.9 m and 1.2 m fans, respectively. Hence, use of a single fan performance curve would have introduced gross errors into the determination of airflow rate of seemingly identical ventilation fans.

Depending on the brand and operating conditions of the ventilation fans, certain airflow reduction or penalty due to the presence of the FANS might occur (Gates et al., 2004) and should be accounted for in determining the actual airflow rate of the fan. The type of fans and their operation conditions for this commercial layer house would experience negligible penalty, according to the BESS Lab test results for the same type of fans (K. D. Casey, 2004, unpublished data). Hence, no penalty was applied to the ventilation rate as measured by the FANS unit.

VENTILATION RATE BY INDIRECT CO₂ BALANCE METHOD

Van Ouwkerk and Pedersen (1994) indicated that to ensure reliability of the CO₂ balance method, the difference in CO₂ concentrations between outlet and inlet air should exceed 200 ppm. This criterion was met by our data. Ideally, CO₂ concentration of inlet or fresh air is constant at about 350 ppm. In reality, CO₂ concentrations of the inlet (or purging) CO₂ concentration of inlet or fresh air is constant at about 350 ppm. In reality, CO₂ concentrations of the inlet (or purging) air ranged from 350 to 500 ppm, presumably due to partial return of the exhaust air. The difference between inlet and outlet air CO₂ concentrations varied from 206 to 3089 ppm during the measurement period. The maximum

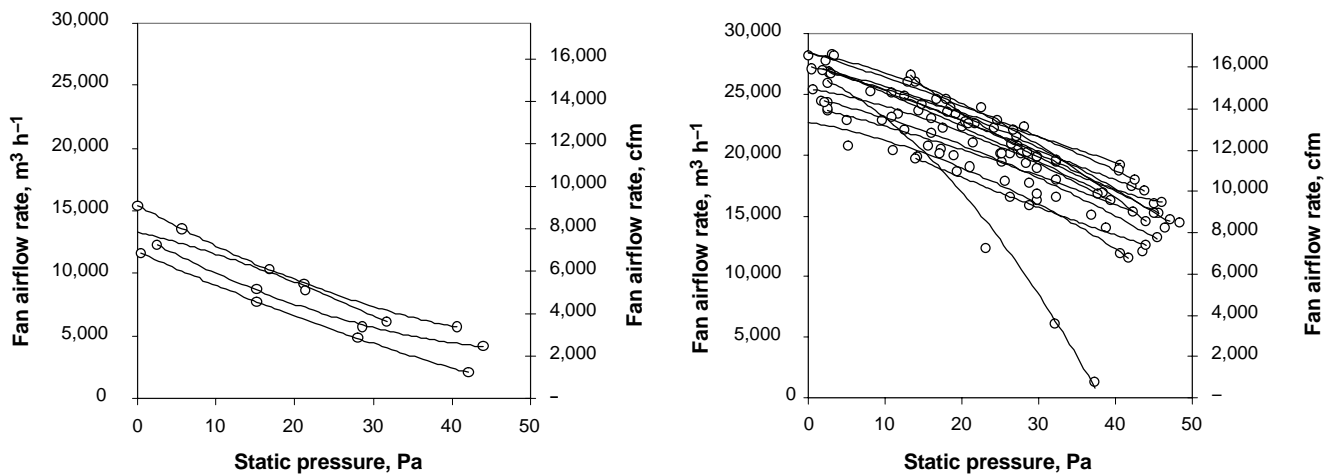

Figure 4. Performance curves of the 0.9 m (36 in.) fans (left) and the 1.2 m (48 in.) fans (right) in the monitored commercial layer house (1 cfm = 1.7 m³ h⁻¹).

difference took place in winter (31 December 2003), corresponding to an indirectly determined ventilation rate of $0.43 \text{ m}^3 \text{ h}^{-1} \text{ bird}^{-1}$ ($0.25 \text{ cfm bird}^{-1}$). The minimum difference occurred in summer (22 July 2003), corresponding to an indirectly determined ventilation rate of $5.28 \text{ m}^3 \text{ h}^{-1} \text{ bird}^{-1}$ ($3.11 \text{ cfm bird}^{-1}$). Figure 5 shows the relationship of derived ventilation rate to CO_2 concentration difference. It can be seen that changes or fluctuations in the CO_2 concentration difference affected the derived ventilation rate more at the higher ventilation levels than at the lower ventilation levels, as would be predicted from equation 4.

DIRECTLY VS. INDIRECTLY DETERMINED VENTILATION RATE

Figure 6 depicts the dynamic profile of semi-hourly ventilation rates for a data collection trip (15–17 April 2003). The directly and indirectly determined ventilation rates showed similar patterns in following the outside temperature profile. However, differences of various degrees existed between the two methods. The differences presumably resulted from the dynamic nature of the environmental conditions and activity level of the hens, which would have led to deviation of the dynamic THP from the average values (for light or dark period) used in the calculation. The outside weather, especially wind conditions, also could have temporarily affected the performance of the exhaust fans or air distribution inside the building, which in turn would affect determination of both the direct and indirect ventilation rates.

Figure 7 shows paired comparisons of ventilation rates between the direct and indirect methods at semi-hourly, hourly, bi-hourly (every 2 h), and daily average or integration

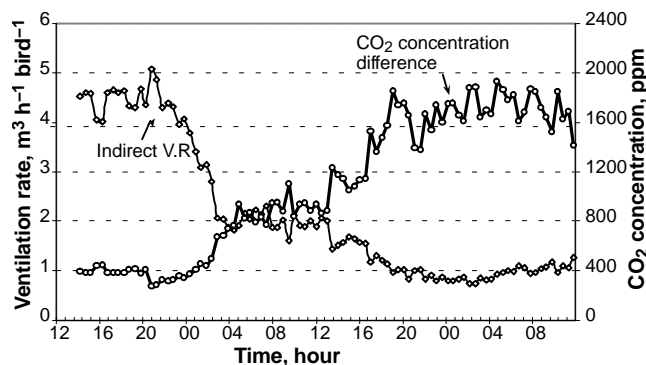

Figure 5. Profiles of semi-hourly CO_2 concentrations and CO_2 balance-derived ventilation rate of the monitored layer house during 15–17 April 2003 ($1 \text{ cfm} = 1.7 \text{ m}^3 \text{ h}^{-1}$).

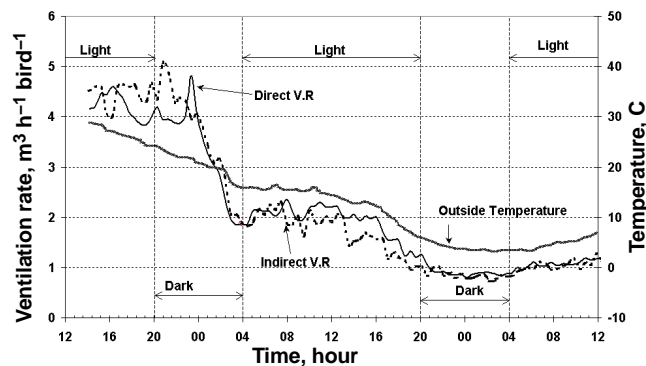

Figure 6. Comparison of directly measured vs. CO_2 balance-derived (semi-hourly) ventilation rate of the monitored layer house during 15–17 April 2003 ($1 \text{ cfm} = 1.7 \text{ m}^3 \text{ h}^{-1}$).

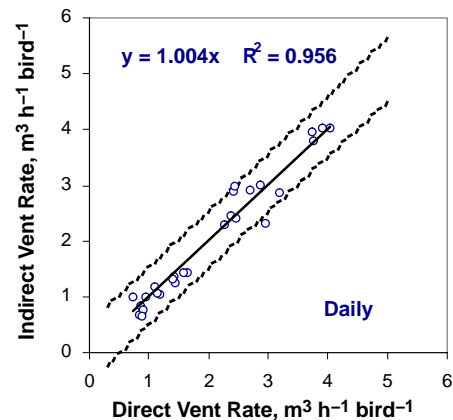
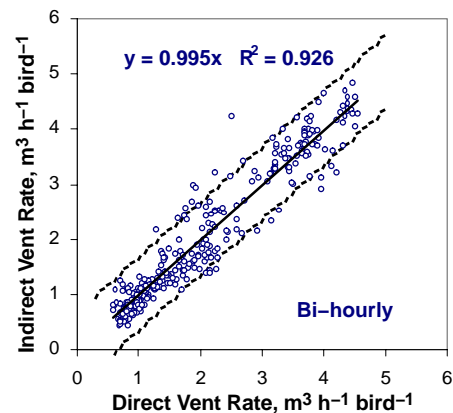
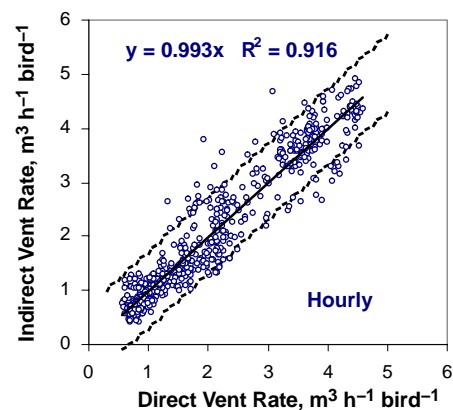
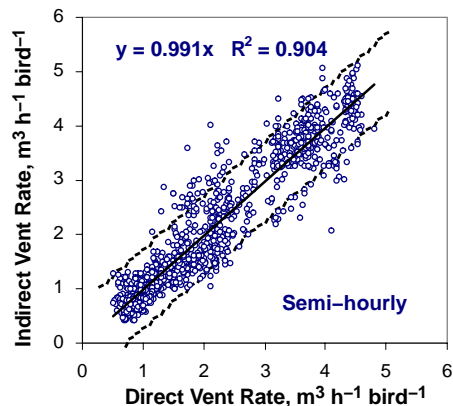

Figure 7. Relationship of ventilation rates determined from direct measurement vs. from CO_2 balance derivation for the monitored layer house at different integration time intervals. The dashed lines below and above the regression lines represent 95% confidence intervals of the observations ($1 \text{ cfm} = 1.7 \text{ m}^3 \text{ h}^{-1}$).

time intervals. The number of observations associated with each of the time intervals was, respectively, 1318, 660, 330, and 28. The corresponding regression lines of indirect vs. direct ventilation rates revealed good regression coefficients (R^2) of 0.904, 0.916, 0.926, and 0.956, respectively. The corresponding P-values of the paired t-tests were 0.019, 0.1, 0.205, and 0.763, respectively. Hence, the results indicate that the CO₂ balance method based on a bi-hourly or longer averaging/integrating time interval would yield ventilation rates not significantly different from those obtained by direct measurement ($P > 0.2$). All regression equations had a slope of nearly unity, indicating that hen manure on the belt contributed little to the CO₂ production inside the house. This seems logical, as the manure was removed from the house daily.

CONCLUSIONS

A CO₂ balance may be successfully used to determine the building ventilation rate of commercial laying hen (W-36 breed) houses using manure belts with daily manure removal when the integration time interval is 2 h or longer. Use of such an integration time interval would dampen down the dynamic effects of the system on the derived ventilation rate. The indirect technique relies on updated metabolic rate of the birds. Daily removal of manure from the layer house made contribution of CO₂ emission from manure negligible compared to respiratory CO₂ production by the birds. This method provides a viable alternative for determining building ventilation rate, a critical factor in measuring air emissions from animal confinement housing.

ACKNOWLEDGEMENTS

Financial support of the study was provided in part by the USDA-IFAFS program and the 6-State Animal Waste Management Consortium. The authors wish to sincerely thank the staff of the commercial layer operation for their enthusiastic and constant cooperation throughout the study.

REFERENCES

- Brouwer, E. 1965. Report of sub-committee on constant and factors. In *Energy Metabolism: Proc. 3rd Symposium held in Troon, Scotland*, 11: 441-443. K. L. Blaxter, ed. Rome, Italy: European Association for Animal Production.
- Casey, K. D., R. S. Gates, E. F. Wheeler, H. Xin, J. L. Zajackowski, P. A., Topper and Y. Liang. 2004. Ammonia emissions from Kentucky broiler houses during winter, spring, and summer. In *Proc. 97th Annual A&WMA Conference and Exhibition: Sustainable Development: Gearing Up for the Challenge*, CD-ROM. Pittsburgh, Pa.: A&WMA.
- Chepete, H. J., and H. Xin. 2004. Heat and moisture production of poultry and their housing systems: Molting layers. *Trans. ASHRAE* 110(2): 247-285.
- Chepete, H. J., H. Xin, M. C. Puma, and R. S. Gates. 2004. Heat and moisture production of poultry and their housing systems: Pullets and layers. *Trans. ASHRAE* 110(2): 268-299.
- Feddes, J. J., J. J. Leonard, and J. B. McQuitty. 1984. Carbon dioxide concentration as a measure of air exchange in animal housing. *Canadian Agric. Eng.* 26(1): 53-56.
- Gates, R. S., K. D. Casey, H. Xin, E. F. Wheeler, and J. D. Simmons. 2004. Fan assessment numeration system (FANS) design and calibration specifications. *Trans. ASAE* 47(5): 1709-1715.
- Phillips, V. R., R. Scholtens, D. S. Lee, J. A. Garland, and R. W. Sneath. 2000. A review of methods for measuring emission rates of ammonia from livestock buildings and slurry or manure stores: Part 1. Assessment of basic approaches. *J. Agric. Eng. Res.* 77(4): 355-364.
- Phillips, V. R., D. S. Lee, R. Scholtens, J. A. Garland, and R. W. Sneath. 2001. A review of methods for measuring emission rates of ammonia from livestock buildings and slurry or manure stores: Part 2. Monitoring flux rates, concentrations, and airflow rates. *J. Agric. Eng. Res.* 78(1): 1-14.
- Simmons, J. D., T. E. Hannigan, and B. D. Lott. 1998. A portable anemometer to determine the output of large in-place ventilation fans. *Applied Eng. in Agric.* 14(6): 649-653.
- Van Ouwerkerk, E. N. J., and S. Pedersen. 1994. Application of the carbon dioxide mass balance method to evaluate ventilation rates in livestock buildings. In *Proc. XII World Congress on Agricultural Engineering*, 1: 516-529. Bonn, Germany: CIGR General Secretariat.
- Wheeler, E. F., R. S. Gates, H. Xin, J. S. Zajackowski, P. A. Topper, and K. D. Casey. 2002. Field estimation of ventilation capacity using FANS. ASAE Paper No. 024125. St. Joseph, Mich.: ASAE.
- Xin, H., A. Tanaka, T. Wang, R. S. Gates, E. F. Wheeler, K. D. Casey, A. J. Heber, J. Ni, and T. Lim. 2002. A portable system for continuous ammonia measurement in the field. ASAE Paper No. 014168. St. Joseph, Mich.: ASAE.