

DEVELOPMENT OF TRANSDUCERS FOR NDE

G. S. Kino, B. T. Khuri-Yakub, A. Selfridge, and H. Tuan
Stanford University
Stanford, California 94305

ABSTRACT

Several new types of transducers are described. These include 50 - 500 MHz transducers using thin film technology and indium techniques, transducer arrays for imaging, edge-bonded transducers, and unipolar transducers.

INTRODUCTION

It has been necessary during the course of our research to develop several new types of transducers for nondestructive testing. The best commercial transducers available exhibit broad bandwidth but are usually highly inefficient. Good surface wave transducers are not easily available; transducer arrays for imaging were required, and extremely high frequency transducers for work on ceramics were needed. In addition, we have been interested in developing transducers which could produce a unipolar pulse. It has therefore been necessary to develop design theory for transducers and to improve the technology for making them. This has involved a careful study of bonding techniques and the use of thin film technology which in the past has been widely employed for acoustic surface wave devices.

PISTON TRANSDUCERS

We have recently published a paper on the design of piston transducers for use in medical and NDE applications,¹ so we will not describe these transducers in much detail. The basic philosophy of design of our low frequency transducers intended for excitation of waves in water has been to improve the efficiency of excitation of waves from the high impedance piezoelectric transducer material to the low impedance water medium by using one or more quarter wavelength matching layers. This provides a broadband match with two way conversion efficiencies as low as 3.5 dB. This measurement was carried out using an electrical input, reflecting the emitted wave from a perfect reflector back to the transducer, then determining the electrical output into a 50 ohm load. At the same time, the transducers gave an excellent and compact impulse response. This basic philosophy has also been used in our transducer array designs.

When one is interested in transduction directly into solid materials which have an impedance close to that of the transducer material, quarter wavelength matching layers are not required. So at low frequencies, we have made transducers which are bonded to an aluminum buffer rod and demonstrated good broadband response and efficiency. We have carried this philosophy into the design of transducers operating in the 50 to 500 MHz frequency range, which is intended for examining ceramics. For very high frequencies, we employ a thin film technology, illustrated in Fig. 1. A gold film is laid down on a sapphire buffer rod on which a ZnO layer one quarter to one half wavelength thick is laid down by rf sputtering; the ZnO layer, in turn, has a small electrode, which defines the diameter of the beam, depos-

ited on top of it. This forms a broadband transducer whose characteristics are shown in Fig. 2. The transducer is contacted to a ceramic work piece by arranging that the front surface of the sapphire buffer rod has a radius of the order of 20 cm. Under relatively small forces of the order of 50 pounds, this produces a Hertzian contact with a diameter of the order of 1 mm on the ceramic surface, which has a reflection coefficient of the order of .1. This is large enough to allow a well-defined high frequency cylindrical beam operating in the 100 to 300 MHz range to be passed through it. Such transducers give a return efficiency of the order of -20 dB.

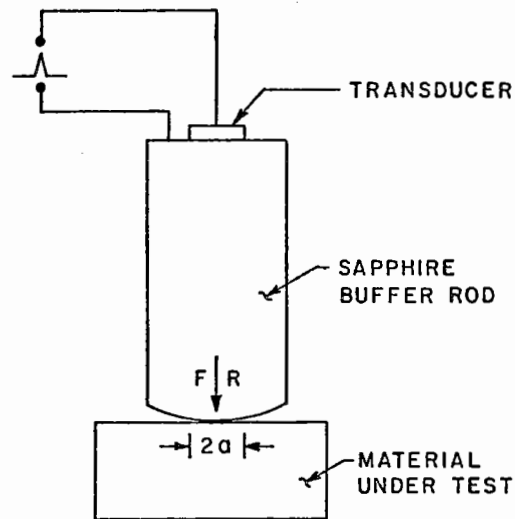

$$\begin{aligned} R &= 20 \text{ cm} \\ 2a &= .1 \text{ cm} \\ F &= 172 \text{ N} \approx 39 \text{ Lbs.} \end{aligned}$$

Fig. 1. Illustration of a ZnO transducer on a buffer rod.

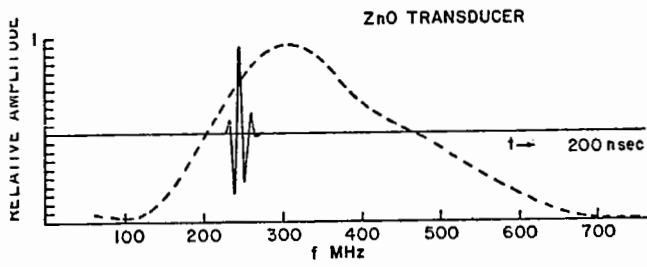

Fig. 2. The pulse and frequency response of a ZnO film transducer.

The ZnO technology is at its best for use with frequencies higher than 200 MHz. Otherwise because the thickness of the film must be chosen for either a quarter or half wave resonance, the films are required to be too thick ($> 8 \mu\text{m}$) to be conveniently deposited. So it is then necessary to use a different type of technology in which a layer of single crystal lithium niobate (LiNbO_3) or a piezoelectric ceramic is lapped down to the requisite thickness. We have made transducers of this kind for use in the frequency range from 10 to 300 MHz, but the technology is most convenient for 50 or 100 MHz transducers. One problem with this technology is that the bonding layer between the piezoelectric material and the buffer rod should be very thin, preferably having an acoustic impedance comparable to the materials to be bonded. We have employed an indium bonding technique for this purpose. This involves depositing gold layers approximately 1000 Å thick on the two surfaces to be joined. Then the two mating pieces are placed in a vacuum system, and indium layers of the order of 1000 Å are deposited on top of the gold layers. The two mating pieces are then pressed together, while still in the vacuum, and form a diffusion bond at room temperature. This diffusion bond has excellent impedance matching properties; in fact, the technique has been used up to 10 GHz by groups in several laboratories.

An illustration of the response of a 50 MHz transducer made this way is shown in Fig. 3. Typical losses of 50 MHz transducers and 200 MHz transducers are less than 10 dB from input to output with a perfect reflection from the end of the buffer rod. We have used buffer rods of sapphire and of silicon nitride ceramic. We employ LiNbO_3 for the higher frequency transducers because it is the ideal material for the purpose. But its dielectric constant is not large enough for a low enough impedance transducer at 50 MHz. In this case, the best material is potassium sodium niobate (PSN) ceramic which has a dielectric constant of 300 to 400, as compared to LiNbO_3 which has a dielectric constant of 39. We have made both shear wave and longitudinal wave transducers with these materials; we have also been able to make good longitudinal and shear wave contact through Hertzian contacts on the end of the buffer. This has been very convenient, because for NDE of ceramics up to 300 MHz, shear wave transducers cannot be made with a thin film technology. It has also been extremely convenient for low frequency experiments where we wish to make a transducer that can be moved from point to point easily under computer control. No grease is needed at the contact, and the forces required between the transducer and the

substrate of interest are relatively low.

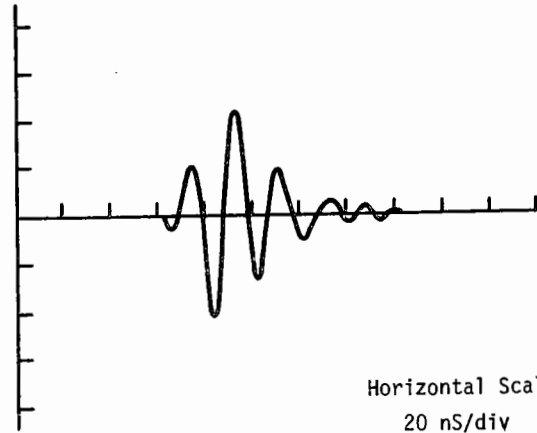
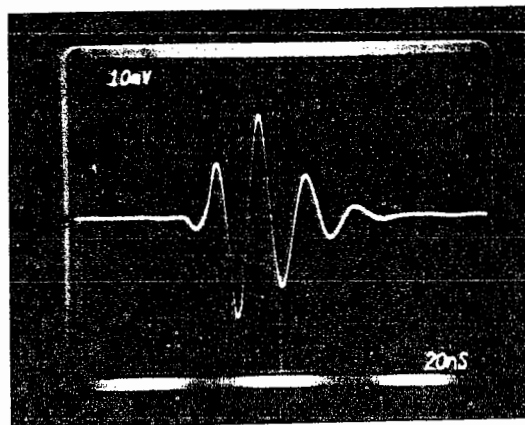
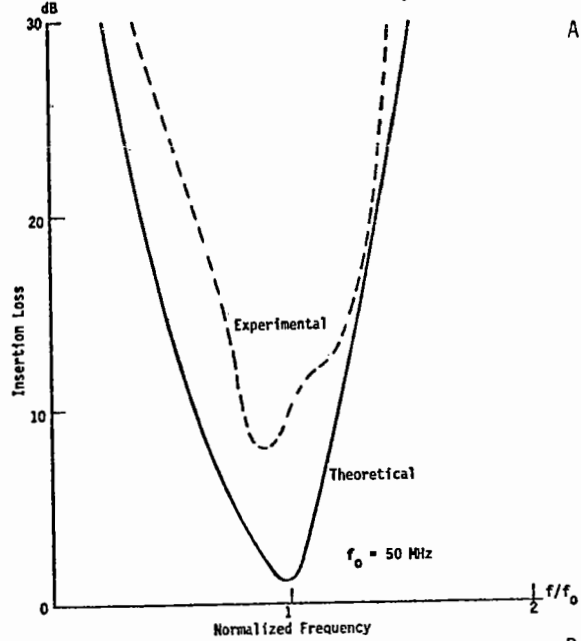
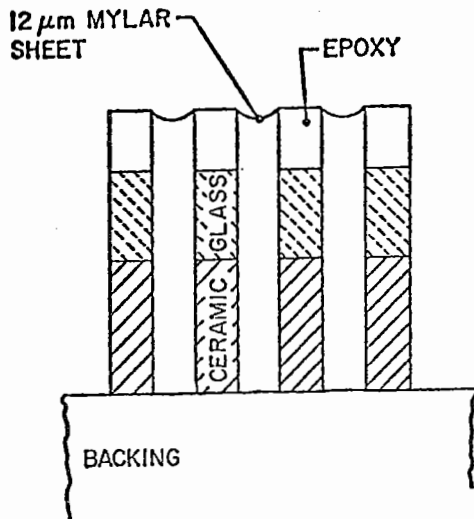

Fig. 3. (A) Insertion loss versus normalized frequency plot of a typical PSN/fused SiO_2 transducer (50 MHz center frequency); impulse response of a typical PSN/fused SiO_2 transducer (50 MHz center frequency) (B) experimental impulse response, and (C) theoretical impulse response.

TRANSDUCER ARRAYS

The design of transducer arrays for acoustic imaging systems is a more severe problem. The requirements are for broadband efficient operation, each element being able to excite a beam with an angle of acceptance which is possibly as large as $+50^\circ$; furthermore, all the array elements must be identical in their frequency and amplitude response. Two types of arrays are required: one which can excite a wave in water, and the other which can excite either longitudinal, shear, Lamb, or Rayleigh waves directly on metal or ceramic substrates. So far, we have mainly concentrated on transducers which can excite waves in water and then used mode conversion for excitation of various types of waves in metals. More recently, we have constructed a different type of array, the edge-bonded transducer array, which is far easier to make than the first alternative, provides better efficiency, and, we believe, is the fore-runner of a large class of a range of new types of transducers.

An illustration of the basic form of the arrays used for exciting waves in water is shown in Fig. 4. The individual PZT ceramic elements operate at a center frequency of 3 MHz with an octave bandwidth and are approximately .3 mm wide \times .5 mm high. In addition, they have one or two quarter wavelength matching layers, typically glass and epoxy, of the same width laid down upon them. The arrays are made by epoxy bonding the three layers together. The PZT ceramic element is bonded to a backing of tungsten epoxy or other filled epoxy. Individual elements are constructed by diamond sawing slots into the medium down to the backing. A thin layer of plastic such as mylar is bonded to the front surface to protect the elements from water. The array elements must be thin in order to give a large angle of acceptance and to avoid transverse resonances which can interfere with the broadband operation and reduce the efficiency.



(SECTION VIEW ENLARGED
TO SHOW DETAIL)

DRAWING NOT TO SCALE

Fig. 4. Assembly drawing of longitudinal wave transducer array.

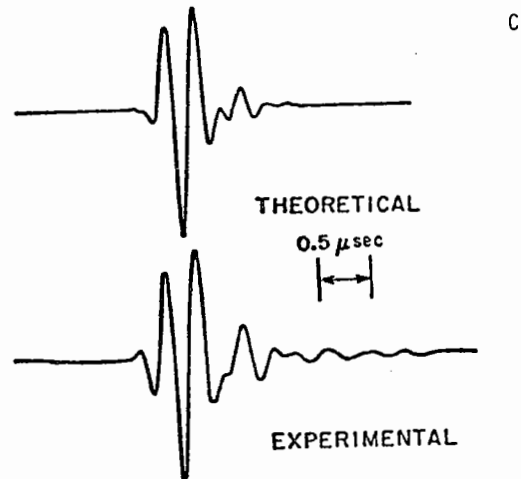
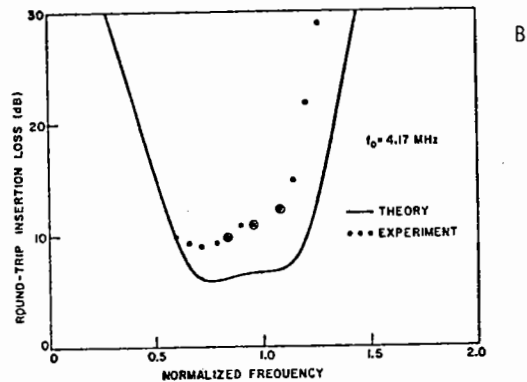
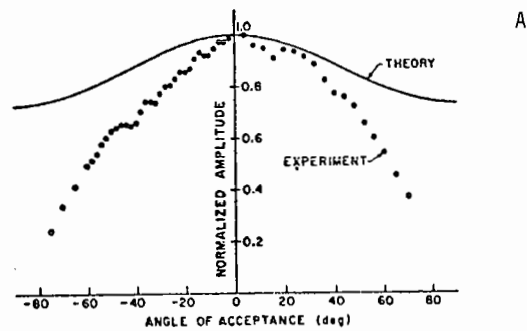

Fig. 5. (A) Comparison of theoretical and experimental angular acceptance of one element of test array. Element dimensions are $0.476 \text{ mm} \times 0.18 \text{ mm} \times 1.27 \text{ cm}$. Glass thickness is 0.305 mm . Epoxy thickness is 0.109 mm . Mylar face plate is 0.0127 mm thick; (B) Comparison of theoretical and experimental insertion loss of one element of the same test array as in (A); (C) Comparison of theoretical and experimental impulse response of element of the same test array as in (A).

Arrays of this type have proved to be extremely difficult to make reliably, basically because of the fragility of the elements and the many steps involved in their manufacture. Response characteristics of some of our better performing array elements of a double quarter wavelength matched system are shown

in Fig. 5. Systems of this type have been employed in our acoustic imaging device and are the ones used for demonstrating most of our imaging in water. We employ these kinds of arrays to excite waves in metals by exciting the waves at an angle to the metal surface as shown for Rayleigh waves in Fig. 6. This has enabled us to carry out imaging using Rayleigh waves and using shear waves in metals.

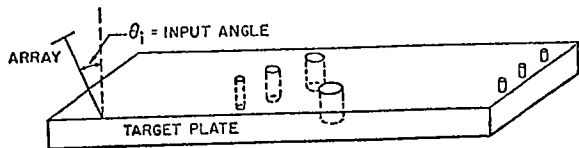

Fig. 6. A schematic of the setup used to excite Rayleigh waves in target plates from an array in water. For Rayleigh waves in aluminum, the angle $\theta_i \approx 28^\circ$.

The problems of mode conversion have become more severe as we have improved our imaging systems. The difficulty is that the mode conversion process introduces aberrations into the image because of the differences in velocity between the waves in water and the waves in the metal so that as the angle of attach of the array entering the metal is changed, the time and phase delays of the arrays change slightly. This makes the problem of the design of the imaging system very difficult. It was not a problem in our earlier systems; it has only become a problem now that the imaging systems have definitions of the order of .5 mm. Accordingly, we have designed a new type of imaging array, the edge-bonded array illustrated in Fig. 7, which we believe shows great promise. This array is used to excite surface waves on a metal substrate. A ceramic transducer is epoxy-bonded to an aluminum substrate as shown in Fig. 8. Thin film electrodes are deposited on the back of the ceramic, which is itself approximately a half Rayleigh wavelength thick. The electrodes are themselves approximately one wavelength long in the direction perpendicular to the top surface of the metal and ceramic. These electrodes, therefore, efficiently excite a Rayleigh wave whose penetration depth is of the order of one wavelength. The individual electrodes themselves are approximately one wavelength wide and are separated from each other by a gap of the order of a wavelength in which a grounding strip is deposited, to shield the individual array elements, one from the other. Because the impedance match between the ceramic and the metal is fairly close, a wave excited by a single electrode, which forms the array element, does not reflect back and forth in the ceramic, thus avoiding coupling the elements together. So the elements do not need to be slotted.

The response characteristic of this array is shown in Fig. 8 where it will be seen that the angle of acceptance is $\pm 35^\circ$, and the bandwidth of the array is of the order of an octave; the return echo efficiency is of the order of 10 dB. By using the array in the coupling configuration shown in Fig. 8 it is possible to transfer energy from the substrate in which the wave is excited to a neighboring identical substrate material. Two substrates are placed parallel to each other, with a thin layer of plastic between them, the layer of plastic being of the order of 5 mm to 1 cm long. Transfer efficiency from one substrate to the other has been measured to be approximately 2 dB. As will be seen, the

manufacturing process of this array is very simple; furthermore, by backing it with epoxy, one can damp out most of the unwanted resonances fairly easily, and the array response appears to be of good quality.

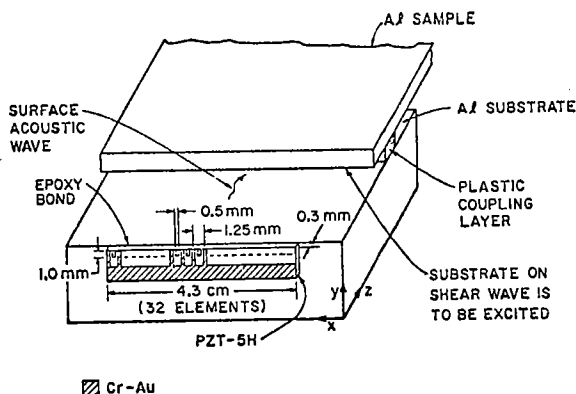

Fig. 7. The edge-bonded 32-element surface acoustic wave transducer array.

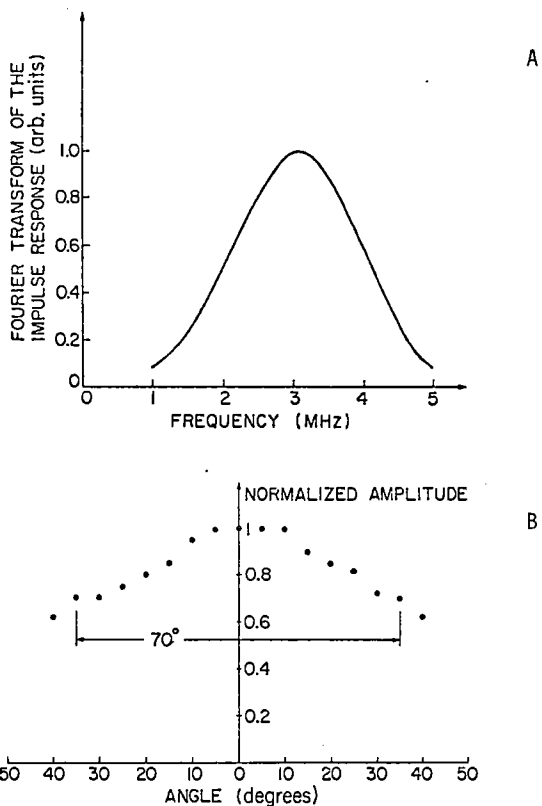

Fig. 8. (A) The impulse response and its Fourier transform of 22 elements of the array, excited in parallel, 0.5 $\mu\text{sec}/\text{Div}$ for the response; (B) the angular response of a single transducer element.

WEDGE TRANSDUCERS

The edge-bonded transducer is one example of the type of transducer that can be used for exciting surface waves. More generally, the classical tech-

nique is to use a wedge-type of transducer in which a bulk wave in a medium (the wedge) in which the wave velocity is less than that of the surface wave on the substrate of interest v_R is employed to excite a surface wave, as shown in Fig. 6. If the angle of incidence θ is chosen so that $v_w = v_R \sin \theta$, good coupling to the surface wave can be obtained. We have carried out a detailed design of such a wedge transducer, for a solid wedge rather than water, and optimized the choice of the wedge material for particular substrates. We have been employing such transducers normally for examining cracks in metals, ceramics, and glass and have been able to calibrate them accurately. These transducers typically exhibit a one-way efficiency of the order of 7 to 10 dB. There is some problem still with unwanted spurious responses in the wedge beyond the transmit main pulse. Typically this can be avoided by using two transducers, one a transmitter and one a receiver, placed at a slight angle to each other.

A technique has also been employed for exciting a surface wave on one substrate and transferring the wave over to a neighboring substrate. This is particularly convenient for high frequency work because it is then possible to design various types of surface wave transducers which are easy to construct at high frequencies. We have done this by making interdigital transducers on LiNbO_3 and placing the substrate at the correct angle to the substrate on which the wave is to be excited, using water as the transfer medium. This type of transducer has been used for examining ceramics with surface waves at frequencies of 64 MHz and 100 MHz.

THE UNIPOLAR TRANSDUCER

Finally, we have been developing unipolar transducers to excite a pulse which is basically of one sign. The reason for our interest in this type of transducer is because we wish to measure slight tapers of acoustic impedance of the material. It can be shown that if one excites a transducer with a pulse of the form $F(t)$, the return echo from a medium whose impedance varies with distance $Z(x)$ will be of the form

$$\begin{aligned} r(t) &\approx \frac{\alpha}{Z} \int \frac{dZ}{dx} F(t - 2x/v) dx \\ &\approx \frac{2\alpha}{Zv} \int Z [\partial F(t - 2x/v) / \partial x] dx \end{aligned} \quad (1)$$

Our aim is to measure stress, which affects the acoustic impedance of the wave, by this technique. It is apparent from the form of the integrals that if the stress varied linearly through a material, as in a sample that was under bending stress, there would be no contribution from a bipolar pulse, but a unipolar pulse would give a good contribution to the return echo which would give a direct measure of the impedance gradient. Alternatively, a step function of applied stress transmitted from the transducer would measure the impedance directly.

We have been able to employ simple commercial transducers to produce unipolar pulses. The basic requirement is to have a well-matched backing and excite the transducer with a step function of voltage with a leading edge which need not rise extremely fast. To detect the unipolar pulse without differentiating it, we have shown that all that is

required is a receiving transducer of the same type connected to a very high impedance load of much higher electrical impedance than the transducer in the frequency range of interest. Two pictures of unipolar pulses obtained by this technique using identical transmitting and receiving transducers placed against each other are shown in Fig. 9. In Fig. 9a, the input pulse has a rise time comparable to the transit time of an acoustic wave through the transducer. In Fig. 9b the rise time is much longer than the transit time T . In this latter case, essentially a step function of stress is generated, which can be used directly for impedance measurements.

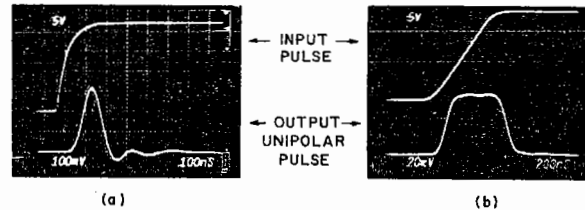

Fig. 9. The unipolar pulse generated by a commercial Panametrics 5 MHz transducer and received on an identical transducer with a high impedance electrical load. (A) Rise time of input pulse ≈ 100 nS (transit time in transducer); (B) Rise time of input pulse $\gg 100$ nS.

The configuration of using the two transducers is not necessarily the most convenient one because of the difficulty looking at reflected echoes this way. We have constructed a two layer transducer, one element being the receiver, one the transmitter. We had originally attempted to use a single transducer with appropriate electronics in which the receiver was of high impedance, but the transmitter was of low impedance; the problem here was to get rid of the transmitter pulse at the time the receiver was turned on. This proved to be too difficult, so it was better to make a two layer transducer. Initial results with a two layer transducer are encouraging, but further development is required. We will be using the indium bonding technique for this purpose which itself solves most of the problems of careful impedance matching required for these transducers.

CONCLUSION

We have described here a wide range of transducer designs required for nondestructive testing. Much remains to be done to limit spurious responses and to improve the ease of manufacture and design of transducer arrays.

ACKNOWLEDGMENTS

This work was supported by the Center for Advanced NDE operated by the Rockwell International Science Center for the Advanced Research Projects Agency and the Air Force Materials Laboratory under Contract RI 74-20773, EPRI Contract RP 609-1, the National Science Foundation under Grant ENG 77-28528, and by the Office of Naval Research Contract N00014-78-C-0283.

REFERENCES

1. C. S. DeSilets, A. R. Selfridge, and G. S. Kino, "Highly Efficient Transducer Arrays Useful in Nondestructive Testing Applications," 1978 Ultrasonics Symp. Proc., pp. 111-116.
2. P. D. Corl, P. M. Grant, and G. S. Kino, 1978 Ultrasonics Symp. Proc.
3. C. S. DeSilets, J. Fraser, and G. S. Kino, 1975 Ultrasonics Symp. Proc. pp. 148-152.
4. C. S. DeSilets, Ph.D. Dissertation, Stanford University, 1978.
5. C. S. DeSilets, J. D. Fraser, and G. S. Kino, IEEE Trans. Sonics and Ultrasonics SU-25, #3, May, 1978, pp. 115-125.

SUMMARY DISCUSSION
(Gordon Kino)

Harold Berger (Session Chairman--Nat. Bureau of Standards): Questions?

Wolfgang Sachse (Cornell University): Aren't the ideas of impedance-matching and bandwidths using quarter-wave layers inconsistent because the quarter-wave layer is going to be operative only at certain frequencies?

Gordon Kino: You could have several layers.

Wolfgang Sachse: Are these layers in series?

Gordon Kino: In series. With two layers from ceramics to water we have 34 to 8 to 3 to 1.5.

Wolfgang Sachse: So, it's analogous to an acoustic horn, in other words?

Gordon Kino: Yes. Or to a microwave transmission line. There are lots of examples in the literature. It's like a tapered transmission line with a few steps, and you can design it to be maximumally flat and so on.

Harold Berger: Thank you.

Chris Fortunko (Science Center-ADL): Why do you need to have the receiving transducer to detect the unipolar pulse? I can see why you need the transmitting transducer.

Gordon Kino: Well, we are not going to measure a stress gradient. We will actually measure the differential of the stress gradient. In a uniform stress gradient, we will get an output which is virtually constant, say. If I differentiate that constant, which I will do if I use a low-impedance load which differentiates the output, I will get nothing. I may be able to integrate up again electrically, but noise-wise I think that's a bad way to go.

Chris Fortunko: To integrate is normally a fairly harmless procedure.

Gordon Kino: Granted. We may be using a sledge hammer to crack a nut maybe. You may be right. I was scared that eventually I would be losing my signal.

Harold Berger: Thank you again, Gordon.

#