

Investigation of interactive teaching techniques to promote student understanding in chemistry

by

Nihal Johnny Behrens

A thesis submitted to the graduate faculty
in partial fulfillment of the requirements for the degree of

MASTER OF SCIENCE

Major: Chemistry (Chemical Education)

Program of Study Committee:
Thomas Greenbowe, Major Professor
Victor Lin
Robert Angelici

Iowa State University

Ames, Iowa

2007

Copyright © Nihal Johnny Behrens, 2007. All rights reserved.

UMI Number: 1447504

Copyright 2007 by
Behrens, Nihal Johnny

All rights reserved.

UMI[®]

UMI Microform 1447504

Copyright 2008 by ProQuest Information and Learning Company.
All rights reserved. This microform edition is protected against
unauthorized copying under Title 17, United States Code.

ProQuest Information and Learning Company
300 North Zeeb Road
P.O. Box 1346
Ann Arbor, MI 48106-1346

TABLE OF CONTENTS

CHAPTER ONE GENERAL INTRODUCTION	1
CHAPTER TWO. USING TUTORIALS IN GENERAL CHEMISTRY RECITATIONS TO IMPROVE STUDENTS' UNDERSTANDING OF CHEMISTRY	21
CHAPTER THREE. MAKING CHEESE USING THE SCIENCE WRITING HEURISTIC APPROACH	60
CHAPTER FOUR. COMPARISON OF STUDENT PERFORMANCE BETWEEN A HIGH AND A LOW SCIENCE WRITING HEURISTIC LABORATORY SECTION	65
CHAPTER FIVE. OVERALL CONCLUSIONS	80

CHAPTER ONE

GENERAL INTRODUCTION

Inquiry

Inquiry is an instructional strategy used in the classroom to promote the acquisition of concepts, knowledge, and problem solving skills. The *National Science Education Standards* (NAS, 1995, p.23) define inquiry as “the activities of students in which they develop knowledge and understanding of scientific ideas, as well as an understanding of how scientists study the natural world” (1). This knowledge development and concept understanding is defined by the students’ ability to use, perform, and follow scientific inquiry. Scientific inquiry is the students’ ability to identify and investigate scientific questions and concepts, explore ideas through hands-on experiences, make and test hypotheses, interpret and analyze data, solve problems, formulate and revise scientific explanations using logic and evidence, recognize and analyze alternative explanations and models, communicate and defend a scientific argument, and have a solid conceptual understanding in order to apply it to new situations.

The learning cycle (2-4) can be simplified as having three phases. In the first phase of the learning cycle students either generate data or they are given data. Students are expected to observe a pattern in the data. This is called the “Exploration Phase”. The data and pattern lead students to the “Concept Invention Phase” where the concept is identified and further investigated. The third phase of the learning cycle encourages students to apply what they have learned to a new situation or new activity. The “Application Phase” is important because students need to be able to use not only the content information they have acquired, but they must also apply problem solving and process skills.

There are various levels of inquiry that take into account the amount of intellectual sophistication of the students and shifting the locus of control between the teacher and the students. The first level of inquiry is discovery learning. Discovery learning is the most basic level of inquiry. It focuses on constructing knowledge rather than applying it. The students at the discovery learning inquiry level use inductive reasoning and build relationships between variables based on the specific experience and topic information introduced by the teacher (28).

Inquiry is used in classrooms and laboratories as a means to help students learn and construct their knowledge since it guides the students to deduce information from data. Student collaboration, group work, and successful engagement are major factors in how well students learn (47).

Inquiry can be applied to any number of subjects, not just science. It has been used in other subject areas, such as social science. However, this paper will focus on using inquiry in science, chemistry in particular (26).

Several theories have been proposed that outline a mechanism for how individuals learn an academic subject. Objectivism is the dominant learning theory in classroom settings. Objectivism states that knowledge exists in books and is independent of thinking. Therefore, Objectivists teach based on the belief that reliable knowledge exists solely in written context and that the educator's job is to transfer their knowledge to the learner and as a consequence the learner's job is to attain that knowledge. As a result, the students have objective learning practices to view objects and phenomena. This objective mind setting is separate from cognitive processes that a student must experience in order to learn. Such cognitive learning experiences include imagination, intuition, and feelings (6-10).

Piaget's Theory of Intelligence

Jean Piaget is a psychologist whose work influenced the field of science education enormously. He was a constructivist and his work gives us enormous insights into how students think and construct knowledge (5). His interest in cognitive development came from his training in the natural sciences. He was interested in knowledge and how children learn. He studied and observed children in order to follow their train and understand the learning process. After many years of observing children in Europe, he proposed a stage model of cognitive development, called Piaget's Theory of Intellectual Development (11-16). He observed that young children are capable of thinking more abstractly as their age increases. He classified and grouped these general thinking skills into three stages. The three stages of Piaget's Theory of Intellectual Development, in order, are pre-operational, concrete operational, and formal operational. At the pre-operational stage (Toddler and Early Childhood), thinking is done in a non-logical and non-reversible manner. At the concrete operational stage (elementary and early adolescence), operational thinking develops and thinking becomes more reversible. The individual at this stage finds proportional reasoning to be challenging. At the formal operational stage (adolescence and adulthood), thinking becomes formal. For the purpose of this study, it is interesting to note that some American freshmen college students have not made the transition from concrete operational to formal operational thinking.

Piaget's theory has been supplanted by Constructivism. Constructivism is a philosophy of learning that essentially states that the students' knowledge and learning starts with their surroundings. They construct their knowledge from the data obtained after it is integrated with prior information and knowledge (5). Constructivism is a way to make sense

of how students learn; it is essentially a theory of knowledge used to explain how we know what we know. Constructivism emphasizes that knowledge already resides in individuals and that knowledge cannot be transferred in one piece from the teacher's head to the students' head. The student only learns and retains knowledge by attempting to make sense of what is taught and fitting it with his or her experiences (6-10).

Memory and Cognitive Load Theory

Memory is a factor that affects student learning. There are three stages of memory: sensory, short-term (working memory), and long-term. The sensory memory stage lasts only a few seconds and has unlimited capacity through which students retain an exact copy of what they hear or see. Selective attention determines what information moves from the sensory stage to the short-term memory stage. The short-term memory stage has limited capacity, in that information seems to decay due to memory loss. The long-term memory stage is permanent, and information is stored based on its meaning and importance (17).

Transferring information from short-term memory to long-term memory involves the encoding of the organized complex information from the short-term memory to the long-term. In order for information to make this important transfer from the short-term to the long-term memory, it has to be relevant and meaningful to the learner (17).

Cognitive load theory states that the best learning takes place in individuals when the working memory load is kept to a minimum in order to best smooth the progress of the changes in long term memory. In addition, that learning requires a connection to the schematic structures of long term memory. The materials will be forgotten if that connection does not occur (18, 19).

Cooperative Learning and Collaborative Inquiry

Cooperative learning is an instructional method where students work in small groups on “structured tasks” (20). This research found that cooperative learning gives the students control of their learning, increases their retention of concepts, and helps them develop better thinking skills (20).

Collaborative inquiry is a fundamental component of creating a student-centered learning environment. Collaborative inquiry is a less structured form of cooperative learning. Through collaborative inquiry, students engage in activities where learning is more independent, which allows the students to build their knowledge in small groups. Collaborative inquiry strategies have several common characteristics. Collaborative inquiry strategies increase the students’ problem solving abilities, help the students learn abstract concepts, help the students share knowledge, strengthen their communication skills and self confidence, and help the students become better critical thinkers (21-24).

The main focus of inquiry is the collaboration between students and their active engagement in discussing topics and problem solving. Inquiry is by no means a new practice, and in actuality is “as old as teaching itself” (25). It is making a substantial comeback because of the recent focus on improved teaching methods and increasing student learning. Table 1 shows the hierarchy of the eight inquiry levels (28). The intellectual sophistication required from the students increases from left to right. The locus of control shifts from the teacher to the students, also from left to right. Therefore, the degree of inquiry increases from the left to the right of the table (28).

Table 1. The eight levels of inquiry

Discovery Learning	Interactive Demonstration	Inquiry Lesson	Guided Inquiry Lab	Bounded Inquiry Lab	Free Inquiry Lab	Pure Hypothetical Inquiry
						Applied Hypothetical Inquiry
Low	← Intellectual Sophistication →				High	
Teacher	← Locus of Control →				Student	

Interactive demonstration is the second level of inquiry and it focuses on the teacher performing a particular experiment or demonstration while asking the students probing questions. The teacher usually gives further explanation of the scientific apparatus and helps the students reach conclusions based on the information provided (28). The third inquiry level is inquiry lesson. The inquiry lesson level shifts the teacher mode from providing leading questions—as in the interactive demonstration inquiry level—to providing guiding questions on a specific scientific topic.

The fourth inquiry level is guided inquiry laboratory. In guided inquiry laboratory activities, the teacher identifies a problem and asks multiple leading questions to help students find procedures to reach the objective associated with a particular concept (28). The fifth inquiry level is bounded inquiry laboratory. In bounded inquiry laboratory activities, students still have an objective associated with a particular concept, however, they are responsible for developing their own experimental procedures. Here, the instructor's role is to serve as a guide asking leading questions to help students perform their tasks (28).

The sixth inquiry level is free inquiry laboratory. The free inquiry level differs from both guided and bounded inquiry laboratory activities in that the teacher does not identify a problem for the students to investigate. The students search for a problem to investigate and

design their own experimental procedures (28). The seventh inquiry level is pure hypothetical inquiry. In pure hypothetical inquiry research is conducted to expand students' knowledge and understanding of laws without applying the problems to the real world. The students explain laws by using hypotheses (28). The eighth inquiry level is applied hypothetical inquiry. Applied hypothetical inquiry focuses on the students' ability to apply prior knowledge to new situations (22). The seventh and the eighth inquiry levels differ solely on the basis of their goals and employ the same intellectual processes.

Inquiry-oriented methods require that students learn science by the following process: make observations, define a particular problem, make a hypothesis, identify variables to be studied, collect and interpret data, and draw a conclusion based on the analyzed data. Inquiry exercises emphasize student understanding of scientific concepts, help the students make the connection between the laboratory and the lecture portion of the science course, and emphasize higher cognitive skills (26).

One of the advantages to inquiry over direct instruction methods is that inquiry gives control of most of the learning to students, as opposed to the teacher controlling what scientific topic is learned and how it is learned. The essence of the inquiry approach is to teach students to be able to handle situations encountered when dealing with the physical world by using techniques and problem-solving skills similar to those applied by research scientists (26). The National Research Council has recommended that laboratory instruction incorporate student inquiry (1).

There is criticism of the inquiry approach to teaching. Some critics argue that any true scientific process must have two components: inductive and deductive. Since inquiry eliminates the verification process of concepts, this removes the inductive part of the

scientific process. Other critics argue that inquiry is not a better way for the student to learn versus traditional instruction methods. There is, however, enough research and evidence to support inquiry as an alternative instruction method (26).

Science Writing Heuristic

The Science Writing Heuristic (SWH) is a type of inquiry teaching format. The term heuristic means a “tool or problem solving device”. As the name indicates, there is also a very important writing component associated with the SWH approach. In the writing component, the students reflect on concepts studied. The students’ reflection includes explaining any sources of error generated during a particular experiment, explaining any assumptions made during a particular experiment (if any), discussing whether their initial ideas have changed after performing the experiment and whether they have new thinking patterns as a result, and finally making a connection between the experiment performed during the laboratory period with the materials learned in lecture. The SWH approach is a teaching format that encourages students to form groups and work collaboratively while engaging in various laboratory tasks (29).

The SWH also encourages scientific reasoning in the laboratory as the students are finding relationships between variables, developing claims based on data, and supporting their claims with evidence. Moreover, the SWH promotes classroom discussion by the instructor’s testing, directing, and challenging of the students’ observations and thinking (30-33).

Looking back at the eight levels of inquiry described above, the SWH falls under the category of bounded inquiry laboratory because the instructor’s role in a bounded inquiry laboratory is to ask guiding questions without providing answers in order to help the students

complete their tasks. Table 2 provides more information on the roles of an SWH instructor as well as the SWH students.

The theory behind the SWH approach is grounded in a constructivist view of learning. A key to successful SWH implementation is the student-centered environment, which is the first point that appears in Table 2 for effective SWH implementation by the teacher. So what does a student-centered SWH environment look like? There are two components to a student-centered SWH environment. The instructor is one component and the students are the other. The instructor in a student-centered SWH environment is constantly moving around asking guiding questions and redirecting the students' questions back to them. In such an environment, the instructor should be encouraging the students to work in groups and discuss data. When it comes to the students in a student-centered SWH environment, they need to be active, engaged, interacting with other students, asking questions, discussing data, and offering concept explanations (29).

Table 2. Instructional sequence of the SWH instructor and students

Effective Teacher Implementation	Student Engagement
Creates student-centered learning environment	Propose beginning questions
Prepares collaborative inquiry lab materials and strategies	Make observations & record data
Guides experimental process	Analyze data & discuss as group
Frames discussions	Propose claims
	Provide supporting evidence
	Summarize with reflective writing

The focus on the SWH approach has been in the laboratory portion of science courses to help students make concept connections between the laboratory and the lecture. The SWH approach differs from a traditional laboratory format in that the students have to think about relationships between questions they ask at the beginning of class that they will investigate later, claims that they make to answer these opening questions upon completion of a laboratory, and finally the evidence that they provide to support their claim based on the data collected, rather than just following a cookbook recipe and leaving the laboratory. Table 3 shows a comparison between traditional and SWH laboratory formats. Table 4 shows the templates that both the instructor and students follow during an SWH laboratory. Table 5 shows the major differences between a traditional and an SWH laboratory instructor (29).

Table 3. Comparison between the traditional and the SWH lab formats

Standard Report Format	SWH Format
1. Title, purpose	1. Beginning questions—What are my questions?
2. Outline procedure	2. Tests-What will I do? How will I stay safe?
3. Data and observations	3. Observations—What can I see?
4. Discussion	4. Claims—What can I claim?
5. Balanced equations, calculations, graphs	5. Evidence—How do I know? Why am I making these claims?
	6. How do my ideas compare with others' ideas (peers, text, instructor, Internet)?
	7. How have my ideas changed?

Table 4. The teacher and student templates for the SWH laboratory

A template for teacher-designed activities to promote laboratory understanding.	A template for the student.
1. Exploration of pre-instruction understanding through individual or group concept mapping or working through a computer simulation.	1. Beginning ideas—What are my questions?
2. Pre-laboratory activities, including informal writing, making observations, brainstorming, and posing questions.	2. Tests—What did I do? How did I stay safe?
3. Participation in laboratory activity.	3. Observations—What did I see?
4. Negotiation Phase I—writing personal meanings for laboratory activity (for example, writing journals).	4. Claims—What can I claim?
5. Negotiation Phase II—sharing and comparing data interpretations in small groups (for example, making a graph based on data contributed by all students in the class).	5. Evidence—How do I know? Why am I making these claims?
6. Negotiation Phase III—comparing science ideas to textbooks or other printed resources (for example, writing group notes in response to focus questions).	6. Reading—How do my ideas compare with others' ideas?
7. Negotiation Phase IV—individual reflection and writing (for example, creating a presentation such as a poster or report for a larger audience).	7. Reflection—How have my ideas changed?
8. Exploration of post-instruction understanding through concept mapping, group discussion, or writing a clear explanation.	8. Writing—What is the best explanation that clarifies what I have learned?

Table 5. Comparing the different approaches of the traditional and the SWH laboratory instructor

Traditional Instructor	SWH Instructor
<p>Tells students what to do and what will happen; beginning questions not discussed.</p> <p>Allows individuals or pairs to work separately from the class.</p> <p>Assigns tasks.</p> <p>Does not promote sharing or analysis of class data. Shows students how to do calculations and tells students what their results mean.</p> <p>Students immediately leave when finished with their work.</p>	<p>Provides opportunities for students to discuss beginning questions.</p> <p>Sets up the lab for student-centered work.</p> <p>Allows students to assign their own groups and tasks.</p> <p>Encourages students to tabulate class data on the chalkboard.</p> <p>Encourages students to analyze and discuss class data as a group.</p> <p>Instructor guides a class discussion of concepts covered in the laboratory.</p>

As seen in the table above, SWH follows a modified learning cycle, where the students first go through an exploration phase in which they discover certain patterns. Following the exploration phase is the concept and term introduction phase. In this phase, the students link patterns to a term and build models. The last phase of the modified learning cycle is the concept application phase, where the students apply the model to a new situation (34).

The exploration phase in the SWH laboratory happens once the students collect the data and discuss the data among their group(s) with the teacher's guidance in order to find trends or anomalies (24).

The concept introduction phase takes place in the SWH laboratory format once the students make connections between the patterns from the data collected and topic

investigated. The concept application phase takes place in the SWH format during the reading and reflection portion of the laboratory report. During the reading and reflection portion of the laboratory report, the students search to find at least one application to the real world of the topic investigated in the laboratory (34).

Overview of the thesis

This thesis focuses on implementing inquiry and the SWH format. Chapter Two of the thesis discusses the use of the inquiry format to conduct recitations focusing heavily on students' collaboration and active engagement. Chapter Three of the thesis discusses the use of the SWH approach to perform a biotechnology laboratory that was originally conducted in a traditional format. Chapter Four discusses a pilot study run in the laboratories of a science course to study the correlation between how well the students use the SWH approach and their performance on laboratory practical exam tasks. Chapter Five provides an overall conclusion for the work discussed.

Recitation Sections

It is important to outline some background information. A recitation is a mandatory class meeting time designated for a particular course at a large university where a typical lecture class is in the hundreds. The students enrolled in the large lecture class, taught by a professor, are also enrolled and divided among recitation sections that are supervised by teaching assistants, typically graduate students. The purpose of these recitations is to help the students better learn concepts explained in the lecture portion of the course and develop problem-solving skills. The recitation can provide students with better conceptual understanding as well as improved problem-solving skills because it is a smaller class size

where no new materials are covered and the students have a better chance of interacting with each other as well as the teaching assistant.

Why use inquiry in recitation? Recitation sections are excellent in theory since their purpose is to help the students improve their understanding of concepts explained in the lecture portion of the course as well as develop problem-solving skills. In the recitation section, students can ask questions and a quiz can be administered. Students can receive some one-on-one instruction from the teaching assistant, and they can observe how their peers solve the assigned homework problems.

Unfortunately, a typical recitation does not serve its purpose. The students are often not interested in being there, since no new material is covered, but are following the mandatory attendance. This causes students to do whatever they need to do as fast as possible in order to leave.

Some students in a recitation section will normally work individually off-task, talk to their peers about unrelated topics, or simply ask the teaching assistant to solve the particular assigned problems at the blackboard for them to copy and leave. This trend was observed by several university professors and graduate students at large universities in the chemical education area (35-40). The motivation for the research outlined in Chapter Two is to present students with opportunities to collaborate with each other—with the teaching assistant facilitating the collaboration—on homework problems focusing on the concepts presented in lecture. In Theory, the collaboration between the students should help them learn the concepts and improve their problem-solving skills. Tutorials, guided inquiry exercises, and homework problems were used in some of these recitation sections as a tool to

accomplish the purpose of the recitation. Table 6 provides an example of a typical homework problem as well as an equivalent inquiry exercise.

Table 6. An example of a typical homework problem compared to a tutorial problem on the molarity concept.

Homework:

What is the volume of the solution that would result by diluting 70.00 mL of 0.0913 M NaOH to a concentration of 0.0150M?

Tutorial:

The drawings below represent beakers of aqueous solutions. Each O represents a dissolved solute particle.

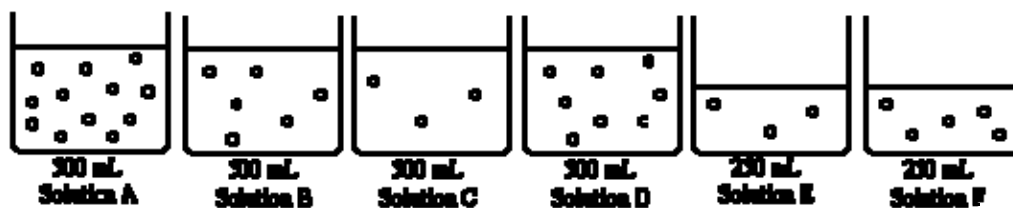

- Which solution is most concentrated?
- Which two solutions have the same concentration?
- When Solutions E and F are combined, the resulting solution has the same concentration as Solution _____.
- If you evaporate off half of the water in Solution B, the resulting solution has the same concentration as Solution _____.

How much 0.05 M NaOH solution can be made by diluting 250 mL of 10 M NaOH

Table 6 above provides an example of a molarity homework problem from end-of-the chapter exercises and a molarity problem designed for the tutorials.

Biotechnology Laboratory

Biotechnology is a technology based on biology used in agriculture, food science, medicine, and industry (41). During an introductory biotechnology course at a community college in Iowa, laboratories were conducted using the traditional cookbook format. The first laboratory, cheese-making activity, serves as a basic introduction to hands-on biotechnology. The goal of the laboratory is to introduce the students to a variety of cheese-making processes, including a biotechnology process, in addition to comparing the performance of the various curdling agents used to make the cheese. The students read the step-by-step procedures, did the laboratory, and left. When their performance on these concepts was evaluated with an exam, similar laboratory task, and discussion with the instructor, their understanding was virtually non-existent. Improving the students' understanding of a very basic biotechnology laboratory was the motivation for rewriting the cheese laboratory using the SWH format.

Laboratory Sections

A pilot study was run in the laboratories of a major university in Iowa to study the correlation between how well students used the SWH approach and their performance on laboratory practical exam tasks. In many studies a correlation was found between how well the SWH approach was implemented by both the instructor and students and how well the students performed on not only a laboratory practical exam but also on lecture exams (42-47). Therefore, the motivation of this work was to study a group of laboratory sections where some sections had good implementation of the SWH approach and the other sections did not. The intent was to determine whether a correlation could be observed when studying

the performance of the students in both types of sections on several laboratory practical exam tasks.

Wrap up

The three studies performed in chemistry recitation sections, chemistry laboratory sections, and a biotechnology laboratory, are all intended to help the students learn the materials better and develop better problem solving skills through inquiry and collaborative work.

References

1. NRC (1995). *National Science Education Standards*. National Research council. Washington, DC: National Research council. Available from <http://www.nap.edu/readingroom/books/nse/html/>.
2. Herron, M.D. (1971). The Nature of scientific inquiry. *School Review*, 79 (2), 171-212.
3. Karplus, Robert. (1964). The science curriculum improvement study. *Journal of Research in Science Teaching*. 2. pp. 293-303.
4. Kotar, M. (1989). The learning cycle. *Science and Children*, 26(7), pp. 30-32.
5. Cracolice, Mark S. (2005). "How Students Learn: Knowledge Construction in College Chemistry Courses." In *Chemists' Guide to Effective Teaching*. N. Pienta, T. Greenbowe, M. Copper (Eds.). Prentice-Hall: Upper Saddle River, NJ.
6. Driver, R. (1989). Changing conceptions. In: P. Adey (Ed.). *Adolescent development and school science*. London: Falmer Press
7. Tobin, K. (1990). Conceptualizing teaching roles in terms of metaphors and beliefs sets. Paper presented at the annual meeting of the American Educational Research Association, Boston.
8. Von Glasersfeld, E. (1981). The concepts of adaptation and viability in a radical constructivist theory of knowledge. In I. E. Sigel, D. M. Brodzinsky, & R. M. Golinkoff (Eds.), *new directions in Piagetian theory and practice* (87-95). Erlbaum: Hillsdale, NJ.

9. Von Glasersfeld, E. (1989). Cognition, construction of knowledge, and teaching. *Synthese* 80(1): 121-140.
10. Wheatley, G. H. (1991). Constructivist perspectives on science and mathematics learning. *Science Education* 75(1): 9-21.
11. Brainerd, C. J. (1978). *Piaget's Theory of Intelligence*. New Jersey: Prentice Hall, Inc.
12. Evans, R. (1973). *Jean Piaget: The Man and His Ideas*. New York: E. P. Dutton & Co., Inc.
13. Lavatelli, C. (1973). *Piaget's Theory Applied to an Early Childhood Curriculum*. Boston: American Science and Engineering, Inc.
14. London, C. (1988). A Piagetian constructivist perspective on curriculum development. *Reading Improvement*, 27, 82-95.
15. Piaget, J. (1972). *To Understand Is To Invent*. New York: The Viking Press, Inc.
16. Sigel, I. and Cocking, R. (1977). *Cognitive Development from Childhood to Adolescence: A Constructivist Perspective*. NY: Holt, Rinehart and Winston.
17. Donald Clark. *Memory*. (2000).
<http://www.nwlink.com/~donclark/hrd/learning/memory.html> . Accessed 8/29/2007.
18. Sweller, J., (1988) Cognitive load during problem solving: Effects on learning, *Cognitive Science*, 12, 257-285.
19. Sweller, J., (1999) *Instructional Design in Technical Areas*, (Camberwell, Victoria, Australia: Australian Council for Educational Research.
20. Cooper, Melanie M. (1995). *JCE*. Vol 72. No. 2.
21. Nurrenbern, S.C., & Robinson, W.R. (1997). Cooperative learning: A bibliography. *Journal of Chemical Education*, 74, 623-624.
22. Cooper, M. M. (2005). An Introduction to Small-Group Learning. In N. P. Pienta, M. M. Cooper, & T. J. Geenbowe (Eds.), *Chemists' Guide to Effective Teaching* (pp. 117-128). Upper Saddle River, NJ: Prentice-Hall.
23. Lloyd C., & Beard, J. (1995). *Managing classroom collaboration*. London: Cassell and Co publishing.
24. Lunsford, A. (1991). Collaboration, Control, and the Idea of a Writing Center. *Writing Center Journal*, 12, 3-10.

25. Clarke, A and Erickson, G. (2006) *BC Educational Leadership Research*.
26. Colburn, A. (2000) *Science Scope*, An Inquiry Primer.
27. Abraham R Michael. (2005). "Inquiry and the Learning Cycle Approach." In Chemists' Guide to Effective Teaching. N. Pienta, T. Greenbowe, M. Copper (Eds.). Prentice-Hall: Upper Saddle River, NJ.
28. Wenning, Carl J. (2004). *Journal of Physics Teacher Education*. Levels of inquiry: Hierarchies of pedagogical practices and inquiry process. 2 (3) pp. 3-11.
29. Greenbowe, T.J., & Hand B. (2005). Introduction to the Science Writing Heuristic. In N. Pienta, M. Cooper, T.J. Greenbowe (Eds.) *Chemists' Guide to Effective Teaching* (pp. 140-154). Upper Saddle River, NJ: Prentice-Hall.
30. Hand, B.M.; Prain, V.; Lawrence, C.; Yore, L. (1999). A Writing in Science Framework Designed to Enhance Science Literacy. *Intl. J. Sci. Educ.* 10, 1021-1036.
31. Hand, B.M.; Prain, V. (2002). Teachers implementing writing-to-learn strategies in junior secondary science: A case study. *Sci. Educ.* 86, 737-755.
32. Keys, C.W.; Hand, B.; Prain, V.; Collins. S. (1999). Using the Science Writing Heuristic as a Tool for Learning from Laboratory Investigations in Secondary Science. *J. Res. Sci. Teach.* 36, 1065-1084.
33. Prain, V.; Hand, B.M. (1996). Writing for Learning in Secondary Science: Rethinking Practices. *Teach. and Teacher Educ.* 12, 609-626.
34. Burke, K. A., Greenbowe, T. J., Poock, J. R., & Hand, B. M. (2005). Using the Science Writing Heuristic: Training chemistry teaching assistants. *The Journal of College Science Teaching*, 35, 36-41.
35. Heyworth, R.M. (1999) *Int. J. Sci. Educ.*, 21, 195-211.
36. Yager, R.E., Snider, B.; Krajcik, J. (1988) *J. Res. Sci. Teach.* 25, 385-396.
37. Herron, J. D.; Greenbowe, T.J. (1986) *J. Chem. Educ.* 63, 528-531.
38. Lythcott, J. (1990) *J. Chem. Educ.* 67, 248-252.
39. Nurrenbern, S. C.; Pickering, M. (1987) *J. Chem. Educ.* 64, 508-510.
40. Sawrey, B. A. (1990) *J. Chem. Educ.* 67, 253-254.

41. Ellyn Daugherty. (2007) *Biotechnology science for the new millennium*. (pp. 3-19, 209-210, 216-217). Paradigm Publishing. St.Paul.
42. Rudd, J. A. II; Greenbowe, T. J.; Hand, B. M. (2001/2002) *J. Coll. Sci. Teach.*, 31, 230-234.
43. Rudd, J. A. II; Greenbowe, T. J.; Hand, B. M.; Legg, M. J.(2001) *J. Chem. Educ.* 78, 1680-1686.
44. Keys, C.W.; Hand, B.; Prain, V.; Collins, S. (1999) *J. Res. Sci. Teach.* 36, 1065-1081.
45. Hand, B.; Keys, C.W. (1999) *Sci. Teach.* 66, 27-29.
46. Greenbowe, T.J.; Hand, B.M. (2005). "Using the Science Writing Heuristic to Improve Students' Understanding of Chemistry." In Chemists' Guide to Effective Teaching. N. Pienta, T. Greenbowe, M. Copper (Eds.). Prentice-Hall: Upper Saddle River, NJ.
47. Abraham, M.R. and Renner, J.W. (1986). The sequence of learning cycle activities in high school chemistry. *Journal of Research in Science Teaching*, 23(2), 121-143.

CHAPTER TWO

**USING TUTORIALS IN GENERAL CHEMISTRY RECITATIONS TO IMPROVE
STUDENTS' UNDERSTANDING OF CHEMISTRY**

Abstract

Nihal J Behrens, Northwest Iowa Community College Sheldon, IA 51201; K.A. Burke, and Thomas J. Greenbowe, Department of Chemistry, Iowa State University of Science and Technology, Ames, IA 50011.

The motivation for doing this research was to investigate whether typical end-of-chapter problems in general chemistry textbooks or guided-inquiry tutorials influence student performance on quizzes and exams. Tutorials and guided-inquiry exercises were incorporated into a college general chemistry recitation curriculum at a University located in the Midwest. The performance on quizzes and exams of students using tutorials was compared to the performance of students doing end-of-chapter problems. Scores on the ACS California Diagnostic Exam (CALD) at the beginning of the study were used as a basis of comparison between the two groups. Teaching assistant-led recitation sections were randomly divided into A and B groups. Groups A and B had four recitation sections each. Prior to the first exam, students in Group A were administered tutorials while students in Group B did comparable homework exercises. Then, prior to the next exam, students in Group B were administered tutorials while students in Group A did comparable homework problems. After a total of four exams, students' performance was compared by studying questions (both conceptual and algorithmic) on quizzes, and hour exams. The results of this study indicated that students who proficiently used tutorials, performed better on quizzes and exams compared to students who did the end-of-chapter problems. The performance of students on

exams and quizzes depended on how well the teaching assistants facilitated inquiry and group work while using the tutorials.

Keywords: Chemical Education Research, Tutorials, Student-Centered Learning, Inquiry-Based Activities, and General Chemistry

Introduction

Inquiry activities have been implemented in the chemistry laboratory since many studies have shown that students lack the connection between the laboratory and the lecture portions of science courses (1-3). These inquiry laboratory activities have been found to promote active learning and help students better learn and retain science concepts (4-6). The motivation for doing this study was to see whether active learning could positively influence the recitation and discussion components of a general chemistry course. The positive influence in the recitations that this study was targeting was better student engagement and collaboration, as well as providing the students with better conceptual understanding and problem-solving skills.

Memory is a factor that affects student learning. There are three stages of memory: sensory, short-term (working memory), and long-term. For learning to occur information has to be transferred from the short-term to long-term memory which involves the encoding of the organized complex information from the short-term memory to the long-term. For the students, this information has to be relevant and meaningful enough for that transfer process (7).

Cognitive load theory explains the learning process and states that the best learning takes place in individuals when the working memory load is kept to a minimum in order to

best smooth the progress of the changes in long term memory and that learning requires a connection to the schematic structures of long term memory. The materials will be forgotten if that connection does not occur (8, 9).

Memory and cognitive load theory have been discussed here because they affected certain results in this study. The students' performance was evaluated on both quizzes and exams and their quiz performance on all topics investigated was always better due to less material and the shorter time period between the material and the quizzes versus the increased material and the longer time period between material and exams.

Tutorials have been successfully used in physics recitation and discussion sections for a number of years. McDermott and collaborators found that students who completed tutorials performed better on exams compared to students who did regular end-of-chapter problems from typical college general physics textbooks (10). Figure 1 provides an example of an evaluated exam problem. McDermott and co-workers found that the performance of students solving tutorials surpassed students doing end-of-chapter homework exercises on the circuit problem presented in Figure 1 as well as other complicated resistive circuit problems studied. They found that introducing the students to concept (circuits) followed by guided questions on circuits helped students perform much better on other complex circuit problems than the students doing isolated problems on circuits from end-of-chapter problems (11, 12).

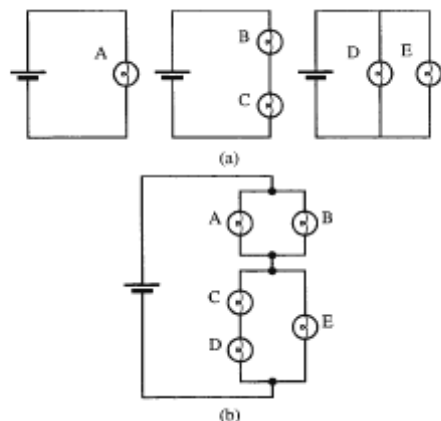

Figure 1. A problem used for understanding of circuits evaluation of students solving tutorials vs. students solving end-of-chapter problems.

McDermott and collaborators were not the only physics educators finding tutorials to be effective for students learning physics in general physics courses. Redish and co-workers from the University of Maryland as well as Meltzer and co-workers from the University of Washington are finding similar results on using tutorials for various topics in a general physics course (13, 14). Figure 2 provides examples of two typical physics homework problems on gases and Figure 3 provides the equivalent tutorial exercises to the homework problems in figure 2. These tutorials are put together by Meltzer and Ngoc-Loan Nguyen (15).

43. A 100 cm^3 box contains helium at a pressure of 2.0 atm and a temperature of 100°C . It is placed in thermal contact with a 200 cm^3 box containing argon at a pressure of 4.0 atm and a temperature of 400°C .
- What is the initial thermal energy of each gas?
 - What is the final thermal energy of each gas?
 - How much heat energy is transferred, and in which direction?
 - What is the final temperature?
 - What is the final pressure in each box?
44. 2.0 g of helium at an initial temperature of 300 K interacts thermally with 8.0 g of oxygen at an initial temperature of 600 K.
- What is the initial thermal energy of each gas?
 - What is the final thermal energy of each gas?
 - How much heat energy is transferred, and in which direction?
 - What is the final temperature?

Figure 2. Typical end-of-chapter physics homework problems on gases taken from Physics for Scientists and Engineers: A Strategic Approach Randall D. Knight Addison-Wesley (2003)

Ideal-Gas Worksheet

The thermal energy [symbol: E_{th}] of an ideal gas is equal to the total kinetic energy of all of the molecules in the gas. According to the kinetic theory of gases, the absolute temperature T of an ideal gas is proportional to the average kinetic energy of the molecules contained within the gas. That is, $T \propto \frac{E_{th}}{N}$ where N represents the number of molecules of gas.

1. Suppose we have two samples, A and B , of an **ideal gas** placed in a partitioned insulated container which neither absorbs energy nor allows it to pass in or out. The gas in Sample A is the **same gas** that is in Sample B . Sample A has the **same mass** as sample B and each side of the partition has the same volume. Energy but no material can pass through the conducting partition; the partition is rigid and cannot move.

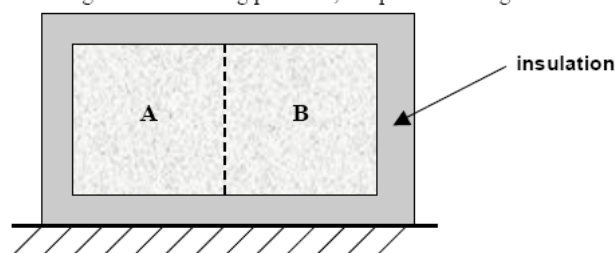

- a. Consider the two equal masses of ideal gas, A and B :
- i. If the thermal energy of A is equal to the thermal energy of B ($E_{th,A} = E_{th,B}$), will the temperature of A be the same as the temperature of B , or will it be different?
 - ii. Suppose the ratio of internal energies is $\left(\frac{E_{th,A}}{E_{th,B}}\right)$; would the value of the ratio $\left(\frac{T_A}{T_B}\right)$ be *greater than, less than, or equal to* $\left(\frac{E_{th,A}}{E_{th,B}}\right)$?

On the bar chart on the next page, the values of the samples' thermal energy are shown at some initial time ("Time Zero"); "Long After" refers to a time long after that initial time. Refer to the set of three bar charts to answer the following questions.

- b. Find the absolute temperature of sample A at time zero (the initial time), and plot it on the chart.
- c. After the initial time, would you expect to see any changes in the temperatures of samples A and B ? If yes, describe the changes (i.e., increases or decreases), and explain your answer. If you don't expect to observe any changes, explain why.
- d. A long time after time zero, what ratio do you expect for the temperatures of the two samples?
 $\frac{T_A}{T_B} = \underline{\hspace{2cm}}$?

Figure 3. Tutorial exercises on gas problems.

Ideal-Gas Worksheet

- e. A long time after time zero, what ratio do you expect for the thermal energies of the two samples?

$$\frac{E_{thA}}{E_{thB}} = \underline{\hspace{2cm}}? \text{ Explain.}$$

- f. Complete the bar charts by finding the “Long After” values for temperature and thermal energy, and also the amounts of energy transferred to each sample. (This is the net transfer that occurs between time zero and the time “long after.”) If any quantity is zero, label that quantity as zero on the bar chart. Explain your reasoning below. *NOTE: The missing values (indicated by a thick line on the horizontal axis) are not necessarily zero – you need to determine whether or not they are actually zero!*

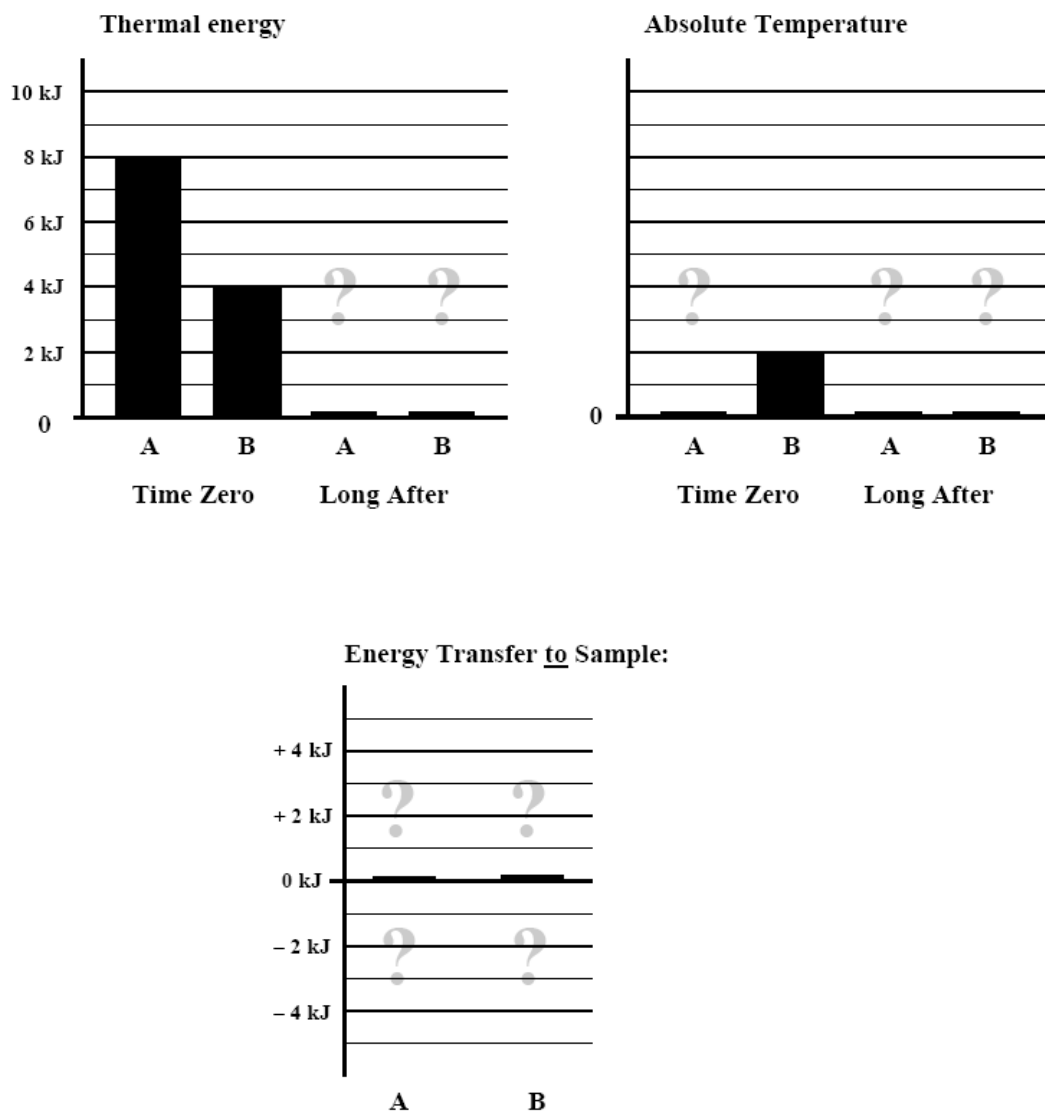
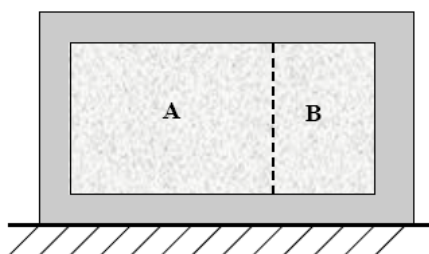

Figure 3. (Continued)

Ideal-Gas Worksheet

2. Suppose we again have two samples, A and B , of an **ideal gas** placed in a partitioned insulated container. The gas in Sample A is the **same gas** that is in Sample B ; however, Sample A now has **twice the mass** of sample B (and the volume of sample A is twice the volume of sample B). Energy but no material can pass through the conducting partition; the partition is rigid and cannot move.



- a. Consider the two *unequal* masses of ideal gas, A and B :
- i. If A and B have the same thermal energy, will their temperature be the same, or different? (Is the average kinetic energy *per molecule* the same, or different?)
 - ii. After the initial time, would you expect to see any changes in the temperatures of samples A and B ? If yes, describe the changes (i.e., increases or decreases). If you don't expect to observe any changes, explain why.

*On the bar chart on the next page, the values of the samples' thermal energy are shown at some initial time ("Time Zero"); "Long After" refers to a time long after that initial time. **In this case, A and B do NOT have the same initial thermal energy.** Refer to the set of three bar charts to answer the following questions.*

- b. Find the absolute temperature of sample A at time zero (the initial time), and plot it on the chart.
- c. A long time after time zero, what ratio do you expect for the temperatures of the two samples?

$$\frac{T_A}{T_B} = \underline{\hspace{2cm}}?$$
- d. A long time after time zero, what ratio do you expect for the thermal energies of the two samples?

$$\frac{E_{thA}}{E_{thB}} = \underline{\hspace{2cm}}? \text{ Explain.}$$

Figure 3. (Continued)

Ideal-Gas Worksheet

- e. Complete the bar charts by finding the “Long After” values for temperature and thermal energy, and also the amounts of energy transferred to each sample. (This is the net transfer that occurs between time zero and the time “long after.”) If any quantity is zero, label that quantity as zero on the bar chart. Explain your reasoning below. *NOTE: The missing values – indicated by a thick line on the horizontal axis – are not necessarily zero – you need to determine whether or not they are actually zero!*

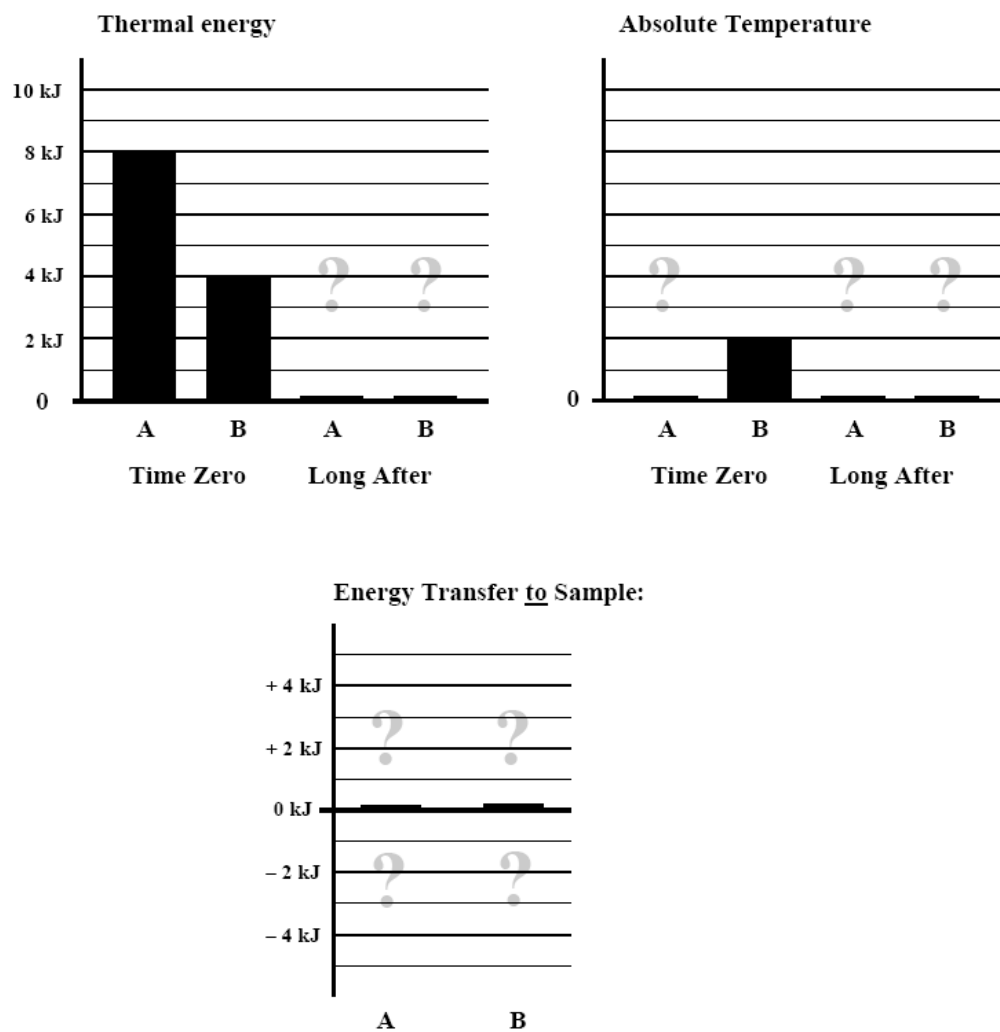

Figure 3. (Continued)

The tutorial samples in Figure Three provide an example of a physics tutorial specifically on the gas topic.

Chemistry Tutorials

In chemistry, Herman and co-workers used web-based tutorials supplementing a particular experiment for their general chemistry course in the fall of 2000 to help their chemistry laboratory students make connections between the science and their everyday experience (16). Parrill and Gervay from University of Arizona used web-discovery-based tutorials to teach stereochemistry. Table 1 provides one example of the tutorials used by Parrill and Gervay to teach organic chemistry. With these tutorials, the students had the ability to view objects in three-dimensions as well as to manipulate computer models of the molecules they built. These tutorials promoted an active learning environment for the students who used them (17). Tissue and co-workers used web-based pre-laboratory tutorials in senior-level Instrumental Analysis during the 1995 fall semester (18). These tutorials provided basic theoretical and experimental descriptions of analytical methods. Outcomes showed that students' conceptual understandings as well as their preparation for the laboratory work were improved.

Table 1. An example of the tutorials used by Parrill and Gervay to teach organic chemistry

Following is the basic structural formula of a double bond between two carbon atoms. Explore several combinations of A, B, C, and D including the same substituent at each position, and different substituents at each position.



What group would you like at position A?



Hydrogen

Table 1. (Continued)

<input type="checkbox"/> Methyl
What group would you like at position B?
<input type="checkbox"/> Hydrogen
<input type="checkbox"/> Methyl
What group would you like at position C?
<input type="checkbox"/> Hydrogen
<input type="checkbox"/> Ethyl
What group would you like at position D?
<input checked="" type="checkbox"/> Hydrogen
<input type="checkbox"/> Methyl
<input type="checkbox"/> Ethyl
<input type="checkbox"/> Bromo
<input type="button" value="Build Structure"/>

End-of-chapter homework problems may not be effective for three reasons. End-of-chapter problems:

1. Present isolated cases and do not allow students to explore a system. The problems normally do not allow students to control variables and to see what effect increasing or

decreasing one variable has on a system. 2. Normally do not encourage interactions between the students. 3. Are not designed to be a component of a learning cycle associated with guided-inquiry learning. Tutorials, on the other hand, can be designed to include the above characteristics of effective learning.

Many students copy answers from a solution manual and copy answers from their peers. By doing this, these students mitigate the effectiveness of end-of-chapter problems. Although in-class tutorials have been used in physics for several years and reports have been published as to their effectiveness, studies relating to the use of tutorials in chemistry are few.

Set up and design of study

This study was designed to investigate whether in-class tutorials improved students' performance on quizzes and exams, their problem-solving skills as well as their conceptual understanding, as opposed to completing end-of-chapter exercises.

The general chemistry course consisted of eight recitation sections which were randomly divided into two groups with four sections in each group. The two groups were group A and group B. At the beginning of the course, the students in both groups (all eight sections) took the ACS California Diagnostic Test (CALD) (19, 20) to set a basis of comparison among them. The CALD is a standardized multiple-choice format exam designed to assess chemistry and mathematics skills required for a college general chemistry course. After a lecture on a particular topic, students in Group A or B were either given a number of homework problems to complete or given tutorials that incorporated guided-inquiry activities. The homework problems and tutorials were graded with an emphasis on checking for setting up a problem, applying mathematics, and understanding of concepts.

The grading was done by two chemical educators. Photo copies of the exams were made and one chemical educator graded a set while the other educator graded the other set. The graders compared the grades and an inter-rater reliability of 94% was established. There were approximately 200 students enrolled in 8 recitation sections (about 25 students in a recitation section). Graduate teaching assistants were assigned as the instructors for the required recitation component of the course.

The tutorials were administered during the recitation sections with the students working in groups of 2 or 3 students using an inquiry approach. A typical recitation was fifty minutes long. The tutorials were a series of questions/problems on a particular chemistry topic. The question series starts at a basic level to help students understand the topic and moves to more and more advanced questions that test students' knowledge and application of the particular topic. Tutorials were not given during every recitation. The students were ranked by two observers every fifteen minutes during a recitation session with regards to their interactions discussing the tutorial exercises within their own group, with other groups, and finally with the teaching assistant (Figure 2). During a 50-minute recitation, the two observers made three separate and independent observations. The two observers met afterwards to discuss their ratings. An inter-rater reliability of 90% was achieved for all of the recitation sessions.

A. Interactions between a group (2-3 students):

- 3 points Over 50% of students are engaged.
 2 points Less than 50% of the students are engaged.
 1 point Each student is working individually.

B. Interaction among groups:

- 3 points Over 50% of the groups are discussing problems.
 2 points Less than 50% of the groups are discussing problems.
 1 point No interaction among groups.

C. TA to students interactions:

- 3 points The TA is walking around listening to students' discussions and directing questions back at students if asked for an answer.
 2 points The TA is uninvolved.
 1 point The TA answers questions and works problems directly.

D. Student to TA interaction:

- 3 points Students are working with each other with minimal TA involvement.
 2 points Students go to the TA instead of other students from other groups for answers to their questions.
 1 point Students sit around and wait for the TA to solve problems.

Category	15 minutes	15 minutes	15 minutes
A			
B			
C			
D			

Figure 2. Observers' ranking sheet

The homework exercises were also administered during the recitation sections. The students would either work on the selected problems individually, work with their neighbors, work individually but off-task, talk to their peers about unrelated concepts, or ask the teaching assistant to solve the particular problem at the blackboard for them to copy. The two observers found that during a typical "effective" recitation section, the students asked the

teaching assistant to work at the blackboard to explain most of the selected homework exercises for the students to copy.

The experimental design chosen for this study was a time series design (a specific type of quasi-experimental design) (21). This design was selected because it gave the students fair and equivalent treatment throughout the entire study. Prior to the first exam, students in Group A were administered tutorials while students in Group B did comparable homework exercises. For the second exam, students in Group B were administered tutorials while students in Group A did comparable homework problems. Switching continued until a total of 4 exams had been completed. After the fourth exam, the performance of students in Group A and was compared by studying relevant related questions (both conceptual and algorithmic) on quizzes, and hour exams. Table 2 illustrates the experimental design of the tutorial study.

Table 2. The experimental design of the tutorial study

Groups	Period of Exam 1	Period of Exam 2	Period of Exam 3	Period of Exam 4
A	Tutorials	End-of-chapter	Tutorials	End-of-chapter
B	End-of-chapter	Tutorials	End-of-chapter	Tutorials

Research Questions

The research questions for the study were as follows: When implemented effectively, do tutorials improve the students' problem-solving skills, as well as their conceptual understanding when the students' collaboration, degree of engagement, and performance is

evaluated by the observers? Will the students who worked on tutorials perform better on lecture quizzes and exams than students completing comparable homework assignments?

Results and Discussion

The average scores for both groups on the CALD were obtained. Group A scored an average of 18.77 out of 44 possible points (42.65%), and Group B scored an average of 17.98 out of 44 possible points (40.86%). Statistical analysis of both groups' scores on the CALD showed that there were no statistical differences between the two groups at the beginning of the study ($p = 0.41$, α set at 0.0500). Both groups started the course with an equivalent knowledge of beginning chemistry. For this general chemistry course, the end-of-chapter homework problems were assigned from a standard college general chemistry textbook; the tutorials were drafted via collaboration among graduate students and professors at two public universities.

Prior to Exam 1, Group A completed tutorials while Group B did comparable homework problems. As a part of this study, the concept of density was the main focus for Exam 1. Table 3 lists some example questions from a tutorial, a homework problem set, a quiz, and an exam. Students' understanding was evaluated by comparing their performance on a quiz about density and three questions (8, 10, and 11) on Exam 1 that dealt with density.

Statistical analysis was conducted to determine whether there were any statistical differences between the two groups. The results displayed in Figure 4 show the average percent scores on all three exam questions as well as the quiz for each group. For Exam 1 question 8, the average for Group A was 46.10%, while Group B scored 30.00%; for question 10 on Exam 1, the average for Group A was 89.12%, while Group B scored 79.79%; and finally for Exam 1 question 11, the average for Group A was 87.88%, while

Group B scored: 77.25%. When combined, the averages for both groups on the three questions on Exam 1 were Group A: 73.69% and Group B: 58.58%. The averages for both groups on the quiz were, Group A: 87.10% and Group B: 79.80%. An analysis of variance was conducted and the outcome showed that there were statistical differences between the two groups on Exam 1 ($p=0.00$, α set at 0.0500), as well as the quiz ($p=0.04$, α set at 0.0500). These results show that Group A outperformed Group B on both algorithmic and conceptual density questions on the density quiz and on Exam 1.

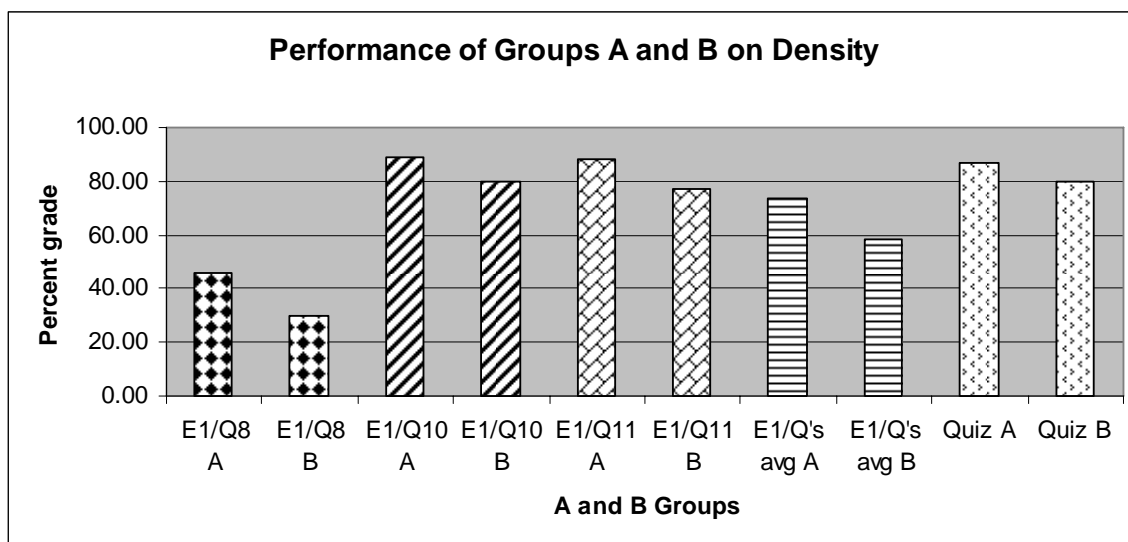

Figure 4. Plot of the students' average scores on Exam 1 questions and quiz. (where E1/Q8 is the groups' performance on Exam 1 question #8 and so on)

Table 3. Example of density questions used for homework, tutorials, quiz, and Exam 1.

Tutorial

A student is given a 1.000 cubic centimeter sample of lead (density = 11.34 g/cm^3), a 1.000 cubic centimeter sample of glass (density = 2.90 g/cm^3), and a 1.00 cm^3 sample of balsa wood (density = 0.12 g/cm^3). Each sample is dropped into separate beakers containing 250 mL of water. How do the volumes of water displaced by each sample compare? Explain.

Table 3. (Continued)

Homework

Imagine that you place a cork measuring 1.30cm X 5.50cm X 3.00cm in a pan of water and that on top of the cork you place a small cube of lead measuring 1.15cm on each edge. The density of cork is 0.235g/cm^3 , and the density of lead is 11.35g/cm^3 . Will the combination of cork plus lead float or sink?

Quiz

Suppose an object has a mass of 305 mg and that this object is a rectangular bar with dimensions of 2.44cm x 1.12 cm x 0.50 cm, will this object float or sink to the bottom when dropped into a beaker of water? Explain your answer. For full credit show calculations. (Density of water is 1.00 g/cm^3)

Exam

A) When a particular marble is dropped into a beaker of water, it sinks to the bottom. Which is the best explanation?

- a. The surface area of the marble is not large enough to be held up by the surface tension of the water.
- b. The mass of this marble is greater than the mass of the water in the beaker.
- c. The mass of this marble is greater than the mass of the water that the marble displaces.
- d. The force from dropping this marble is greater than the surface tension of the water.
- e. The mass and volume of this marble are greater than the mass and volume of the water in the beaker.

B) Briefly explain why the answer that you have chosen above in part A is correct.

During the period leading up to Exam 2, the two groups switched. Group A now did homework exercises while Group B completed tutorials. The main focus of the exam consisted of the concepts of limiting reagent, molarity, and solution stoichiometry. Students' understanding of the limiting reagent concept as well as their problem-solving ability was evaluated by comparing their performance on a quiz and two questions (7 and 10) on Exam 2. The results show the average percent scores on both exam questions along with the average quiz scores for each group. For question 7, the average for Group A was 51.67%, while Group B scored 49.41%; for question 10, the average for Group A was 39.15%, while Group B scored 38.07%. For both questions combined, the average for Group A was

51.67%, while Group B scored 49.41%. Finally, the averages for Groups A and B on the quiz were 74.34% and 65.49% respectively.

The analysis of variance results for the outcome of limiting reagent questions asked on Exam 2 show that there were no significant differences between the two groups ($p=0.36$, α set at 0.0500). However, the analysis of variance for the results of the limiting reagent quiz was significant ($p=0.01$, α set at 0.0500). The fact that there were no significant statistical differences on the exam questions was unexpected (the tutorial groups were expected to do better). These results indicated that Group A (the group that began the study completing tutorials) started and continued to work in groups even during the exam periods were they did end-of-chapter exercises.

Next, the students' understanding of the concept of molarity was evaluated by comparing their performance on a quiz and two questions (8, and 9) on Exam 2. The results show the average percent scores on both exam questions along with the quiz for each group. For question 8, the average for Group A was 48.07%, while Group B scored 50.17%; for question 9, the average for Group A was 80.78%, while Group B scored 81.91%. The combined averages were 63.17% for Group A, and 64.82% for Group B. Finally, the averages for both groups on the quiz were, Group A: 52.11% and Group B: 57.91%.

The analysis of variance results for the outcome of molarity exam questions as well as molarity quiz show that there were no significant differences between the two groups ($p=0.88$, α set at 0.05) and ($p=0.42$, α set at 0.05) respectively. Once again, these results were not expected, but showed that Group B (the group that did not start the study working on tutorials) had now caught up with the group starting the study by completing tutorials.

Finally, the students' understanding of solution stoichiometry was evaluated by comparing their performance on a quiz and question 11 on Exam 2. The results show the average percent scores on the exam question along with the quiz for each group. Question 11 on Exam 2 had five parts, a-e. Only parts c-e were analyzed because in these parts students not only had to identify the reaction type, but they also had to write molecular, ionic, and net ionic equations. On question 11 part c, Group A's average was 21.53%, while group B scored 28.66%. For question 11 part d, Group A's average was 56.05%, while Group B scored 60.16%. For question 11 part e, Group A's average was 56.85%, while Group B scored 62.20%. The averages for both groups on question 11 parts c-e combined were 49.66% for Group A and 53.40% for Group B. The averages of this question were extremely low for both groups due to some confusion in the wording on the question. Finally, the averages for both groups on the Quiz were 54.23% for Group A and 77.22% for Group B.

The analysis of variance results for the outcome of the exam questions related to the concept of solution stoichiometry showed no significant differences between the two groups ($p=0.47$, α set at 0.05), however, the two groups showed significant differences on the solution stoichiometry quiz ($p=0.00$, α set at 0.05). Group B (the tutorial group for Exam 2) outperformed Group A. These results still confirmed the interpretation made from the outcome of the study so far, which is that the tutorial groups were doing better. However, Group A continued to do better so that its performance was comparable with Group B, the group completing tutorials at the time.

For Exam 3, Group A, the group that started the study with the tutorial questions, again completed tutorials, while Group B returned to doing comparable end-of-chapter exercises. Student understanding of the concepts of Lewis structures and periodic trends was

evaluated by comparing their performance on two quizzes (one about electronic structure and electron configuration and the other about periodic trends) in addition to all of Exam 3.

The results showed the average percent scores on the exam along with both quizzes for each group. Exam 3 overall averages were 64.19% for Group A, and 63.08% for Group B; Quiz 7 (electron configurations) the averages were 88.59% for Group A and 80.51% for Group B; Quiz 8, (Lewis structures and trends) the averages were 90.87% for Group A and 74.62% for Group B.

The analysis of variance (ANOVA) results for the outcome of Exam 3 (the entire exam tested both concepts, so the entire exam was analyzed) show no significant difference between the two groups ($p = 0.66$, α set at 0.05) however, the ANOVA results for Quiz 7 and Quiz 8 were significant ($p = 0.00$, α set at 0.05) and ($p = 0.03$, α set at 0.05) respectively. Although results showed that there were no significant differences between the two groups on the third exam, the results from each quiz showed that Group A (the group of students that started the study doing tutorials and the group that was currently doing tutorials) outperformed Group B. These results once again showed that Group B was catching up with Group A and that Group A continued to do extremely well.

For Exam 4 (the last Exam), both groups switched again so that Group A completed end-of-chapter exercises while Group B completed tutorials. During that exam period, concepts studied included calorimetry, physical and chemical processes of heat exchange, and gases. Students' understanding was evaluated by comparing their performance on two quizzes (one on gases and the other on calorimetry) as well as two questions on Exam 4 (one pertaining to gases, the other to the calorimetry concept).

The results showed the average percent scores on two exam questions along with both quizzes for each group. For Exam 4 the average of the calorimetry questions for Group A was 59.03% while that for Group B was 48.54%. The average of the gas questions for Exam 4 was 38.50% for Group A and 38.46% for Group B. For Exam 4 overall results: the averages were Group A: 48.46%, Group B: 45.95%. Quiz 9, calorimetry, the averages for Group A and Group B were 80.14% and 62.95% respectively. For Quiz 10, gases, the averages were 60.59% for Group A and 46.04% for Group B.

The analysis of variance showed that there were no significant difference between the two groups on Exam 4 ($p=0.37$ and α set at 0.05). However, there were significant differences between the two groups on both the calorimetry and the gas quizzes ($p=0.00$, α set at 0.05) and ($p=0.00$, α set at 0.05) respectively. Approximately half of the fourth exam covered algorithmic and conceptual calorimetry problems and the other half covered both algorithmic and conceptual gas problems. The data collected from the exam showed that there was a significant difference favoring Group A for fourth exam calorimetry questions and that both groups performed about the same with respect to the gas questions. For this exam period, two quizzes were given: one about calorimetry and the other about gases. The results show that for both quizzes, Group A did statistically better. These results support the interpretation made earlier, which is that Group A continued to excel and that Group B eventually caught up with Group A. Table 4 provides mean, variance, and standard deviation values for all four exam periods studied.

The final exam scores showed that group A scored 60.0 % while group B scored 59.7%. The analysis of variance showed that there is no statistical differences between the two groups ($p=0.93$, α set at 0.05). The fact that there were no statistical differences between

the two groups shows that once each group experienced active engagement with the tutorials, they continue collaborating even when they went back to end-of-chapter problems.

Therefore, these results prove that active engagement is a key to perform well in chemistry.

Table 4. Summary of study results

Treatments	Group	Mean	Variance	Standard Deviation
Exam 1 density	A	57.92	433.98	20.83
	B	72.87	336.30	18.34
Quiz density	A	86.08	316.45	17.79
	B	79.80	794.27	28.18
Exam 2 L.R	A	8.78	27.00	5.20
	B	8.40	19.81	4.45
Quiz L.R	A	7.43	4.24	2.06
	B	6.55	7.74	2.78
Exam 2 Molarity	A	8.21	11.53	3.40
	B	8.43	12.00	3.46
Quiz Molarity	A	6.76	5.68	2.38
	B	6.77	7.11	2.67
Exam 2 Stoichiometry	A	20.86	88.24	9.39
	B	22.43	80.59	8.98
Quiz Stoichiometry	A	3.25	5.08	2.25
	B	4.63	3.44	1.85
Exam 3 both concepts	A	64.19	233.41	15.28
	B	63.08	279.99	16.73
Quiz e-configuration	A	8.86	1.78	1.33
	B	8.05	8.69	2.95
Quiz Lewis	A	9.09	3.32	1.82
	B	7.46	8.98	3.00
Exam 4 both concepts	A	48.46	297.89	17.26
	B	45.95	300.67	17.34
Quiz Calorimetry	A	8.01	4.47	2.11
	B	6.29	12.24	3.50
Quiz Gasses	A	6.06	4.70	2.17
	B	4.60	8.69	2.95

Conclusions

The outcome of this study showed that Group A, the group starting with tutorials, started and continued to perform as well as or better on quizzes and exams than Group B with or without the tutorials. Students doing the inquiry-based tutorials experienced student-centered learning and thus made better use of their time studying chemistry. This student-centered learning environment created by the tutorials helped students become better problems solvers and helped them better understand chemistry concepts.

The students-centered environment created by using the tutorials continued when the particular group did the end-of chapter problems. This is evidence that students' engagements lead to their success on the quizzes taken due to the cognitive load theory.

This study provides experimental evidence to support having students do guided-inquiry tutorials rather than typical end-of-chapter homework problems from the textbook. First, the tutorials provided a lasting effect with respect to students' retention of chemistry concepts and problem-solving skills and helped students maintain their scores. The students who began solving the guided tutorials (Group A students) continued to do as well as the students who began solving end-of-chapter homework problems (Group B students) when they performed the guided tutorials.

Second, inquiry, group work, and active engagement helped students who worked the tutorials perform better than students working the homework problems in most cases. The students who worked on the tutorials that were arranged in order of increasing concept difficulty achieved better scores due to their active collaboration on the tutorials problems.

Third, tutorials serve as a vehicle for promoting active learning. Discussing and reasoning through the tutorial problems in small groups with the guidance of the teaching

assistant helped the students become active learners, taking responsibility for learning chemistry.

Finally, end-of-chapter homework problems alone were not satisfactory to help general chemistry students develop successful strategies to set up and solve chemistry problems as well as comprehend chemistry concepts. The end-of-chapter homework problems were isolated and did not provide a linear approach to problem-solving. The isolation of the homework problems at the end of a particular chapter did not help the students see a pattern when solving problems on a particular concept, such as with the tutorials.

As seen from the results of the study above, tutorials have an impact on students' learning of chemistry concepts. The trend of improving students' conceptual understanding, and problem-solving skills was observed by various studies in several areas of chemistry and physics (13-17, 22, 23).

Future work with the tutorials include their implementation at a community college to observe whether their effectiveness in better chemistry conceptual understanding and better problem-solving skills holds true at the two-year college level. Additional work involves expanding tutorial implementation to other general chemistry classes at additional two- and four-year institutions.

References

1. Hofstein, A.; Lunetta, V. N. (2004) *Sci. Educ.* 88, 28-54.
2. National Research Council. *National Science Education Standards*; National Academy Press: Washington, DC, 1996.

3. Lazarowitz, R. and Tamir, P. Research on Using Laboratory Instruction in Science. In D. L. Gabel (Ed.); *Handbook of Research on Science Teaching and Learning*; MacMillan: NY, **1994**; pp. 94-122.
4. Tien, L. T.; Rickey, D.; Stacy, A. M. (**1999**) *J. Coll. Sci. Teach.* 28, 318-324.
5. Rudd, J.A.; Greenbowe, T.J.; Hand, B.M.; Legg, M. J. (**2001**) *J. Chem. Educ.* 78, 1680-1686.
6. Poock, J.R.; Burke, K. A.; Greenbowe, T.J.; Hand, B.M. Using the Science Writing Heuristic in the General Chemistry Laboratory to Improve Students' Academic Performance. *J. Chem. Educ.* (in press).
7. Donald Clark. *Memory*. (2000).
<http://www.nwlink.com/~donclark/hrd/learning/memory.html>. Accessed 8/29/2007.
8. Sweller, J., (**1988**) Cognitive load during problem solving: Effects on learning, *Cognitive Science*, 12, 257-285.
9. Sweller, J., (**1999**) *Instructional Design in Technical Areas*, (Camberwell, Victoria, Australia: Australian Council for Educational Research.
10. McDermott, L. C. (**2001**) *Am J. Phys.*, 69, 1127-1137.
11. Lillian C. McDermott, (**1991**). *Millikan Lecture 1990: What we teach and what it learned* ❖ *Closing the gap*, *Am. J. Phys.* **59**, 301.
12. Lillian C. McDermott, *Bridging the gap between teaching and learning: The role of research*, in *Proceedings of the International Conference on Undergraduate Physics Education*, edited by E. F. Redish and J. S.
13. David E. Meltzer, (**1998**). *Effectiveness of instruction on force and motion in an elementary physics course based on guided inquiry*, *AAPT Announcer* 28 (2), 125.
14. David E. Meltzer and Kandiah Manivannan, (**1996**). *Promoting interactivity in physics lecture classes*, *The Physics Teacher* 34, 72.
15. *Physics for Scientists and Engineers: (2003). A Strategic Approach* Randall D. Knight Addison-Wesley pp 570.
16. Herman, C.; Casiday, R. E.; Deppe, R. K.; Gilbertson, M.; Spees, W. M.; Holten, D.; Frey, R. F. (**2005**) *J. Chem. Educ.* 82, 1871-1880.
17. Parrill, A. L., Gervay, J. (**1997**) *J. Chem. Educ.* 74, 329.

18. Tissue, B. M.; Earp, R. L.; Yip, Ching-Wan; Anderson, M. R. (1996) *J. Chem. Educ.* 73, 446.
19. Russell, A. (1994) *J. Chem. Educ.* 71, 314-318.
20. American Chemical Society Division of Chemical Education Examinations Institute, Department of Chemistry, University of Wisconsin-Milwaukee, WI. *California Chemistry Diagnostic Test Form 1993*.
21. Gay, M. & Airasian, A. "Educational Research: Competencies for Analysis and Applications" 2006. NJ: Pearson Education.
22. Abraham, M.R. and Pavelich, M.J. (1979). *Inquiries into Chemistry*. Prospect Heights, IL: Waveland Press, Inc.
23. Michael, J.A.; Modell, H.I. (2003). *Active Learning in Secondary and College Science Classrooms: A Working Model for Helping the Learner to Learn*. Mahwah, NJ: Lawrence Erlbaum Associates.

Supplementary materials

Limiting reagent questions used for homework, quiz, and Exam 2.

Tutorial

1. Which equation, if any, accurately accounts for the reaction above?

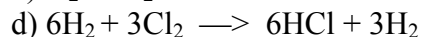
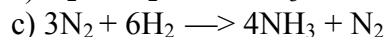
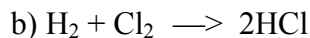
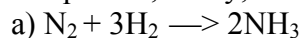

Student 1: *None, because one nitrogen mixed with three hydrogen only gives us one NH₃.*

S2: *C or d, because there was an additional substance left over.*

S3: *A, because for every one molecule of N₂ and three molecules of H₂ there were two molecules of NH₃ created.*

S4: *A or b, because they are possible results when X₂ and Y₂ mix.*

Discuss with a partner which if any of these statements you agree with. Explain.

2. Aspirin is produced by the reaction of salicylic acid and acetic anhydride.

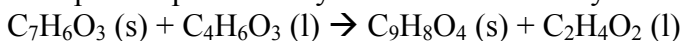

salicylic
acid

acetic
anhydride

aspirin

acetic acid

If you mix 200 g of each of the reactants, what is the maximum mass of aspirin that can be obtained? Note: MM of C₇H₆O₃ = 138.0 g/mol; C₄H₆O₃ = 102.0 g/mol; C₉H₈O₄ = 180.0 g/mol; and C₂H₄O₂ = 60.1 g/mol.

Homework

1. Hydrogen and chlorine react to yield hydrogen chloride. How many grams of HCl are formed from the reaction of 3.56 g of H₂ and 8.94 g of Cl₂? Which reactant is limiting?

2. If 3.42 g of K₂PtCl₄ and 1.61 g of NH₃ give 2.08 g of cisplatin [Pt(NH₃)₂Cl₂], what is the percent yield of the reaction?

Quiz

Ba and O₂ react to produce BaO. Suppose 10.0 g of Ba and 10.0 g of O₂ are allowed to react. What is the limiting reactant? Explain your choice.

Propane, C₃H₈, is a common fuel for a gas barbecue. When propane burns, the reaction that occurs can be described by the following chemical equation:

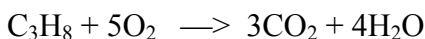

- a. What is the limiting reactant when cooking with a gas grill? Explain your choice.
- b. If the grill will not light, and you know that you have an ample flow of propane to the burner, and the spark or flame is reaching the fuel, what is the limiting reactant?

Exam 2

1. A chemist wished to carry out the following reaction: $A + B \rightarrow C$. Analysis showed that the sample of A was only 90% pure, and that the impurity in the sample of A is unreactive. The presence of this impurity in A will

- Reduce the yield of C by 10%.
- Reduce the yield of C by 10% *only* if reactant B was the limiting reactant.
- Reduce the yield of C by 10% *only* if reactant A was the limiting reactant.
- Increase the yield of C by 10% *only* if reactant A was the limiting reactant. Briefly explain your choice above.

2. Aluminum sulfide and water react according to the equation:

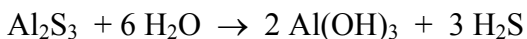

Molar masses: $\text{Al}_2\text{S}_3 = 150.14 \text{ g/mol}$; $\text{H}_2\text{O} = 18.02 \text{ g/mol}$; $\text{Al}(\text{OH})_3 = 77.98 \text{ g/mol}$; $\text{H}_2\text{S} = 34.06 \text{ g/mol}$.

- If 15.00 g Al_2S_3 and 10.00 g H_2O react, what is the limiting reactant? Show your work.
- If 15.00 g Al_2S_3 and 10.00 g H_2O react, what is the theoretical yield (in g) of H_2S ? Show your work.

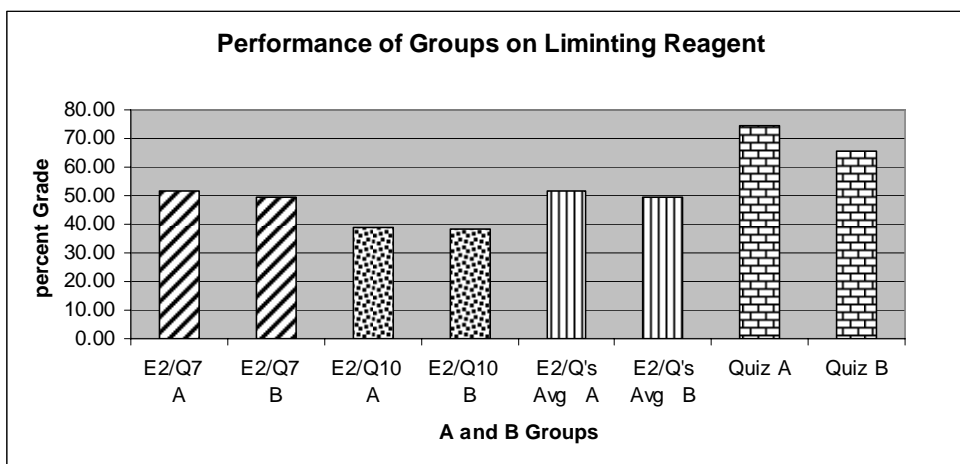

Plot of the students' average score on Exam 2 questions and quiz.

Molarity questions used for homework, tutorials, quiz, and Exam 2.

Tutorial

1. The drawings below represent beakers of aqueous solutions. Each O represents a dissolved solute particle.

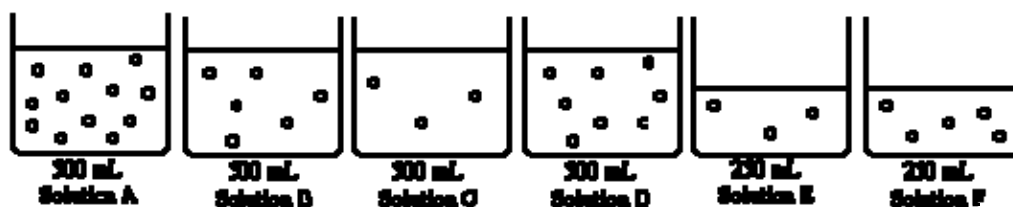

- Which solution is most concentrated?
- Which two solutions have the same concentration?
- When Solutions E and F are combined, the resulting solution has the same concentration as Solution _____.
- If you evaporate off half of the water in Solution B, the resulting solution has the same concentration as Solution _____.

What is the molarity of a solution made when you dissolve 35 grams of NaOH in a volume of 3,400 mL?

2. How much 0.05 M NaOH solution can be made by diluting 250 mL of 10 M NaOH?

Homework

- How many mL of a 0.350M KOH solution contain 0.0171 mol of KOH?
- What is the volume of the solution that would result by diluting 70.00 mL of 0.0913 M NaOH to a concentration of 0.0150M?

Quiz

Suppose 75.0g of NaOH was used to make a solution that was 1.5M in NaOH. What is the volume of the solution in mL?

Exam 2

1. Consider the reaction between H_2SO_4 and NaOH.

- a) Write a balanced chemical equation for this reaction. (You need not include physical states such as (aq) in the equation.)
- b) How many milliliters of a 2.00 M H_2SO_4 solution would be required to react completely with 20.0 g of NaOH (MM = 40.0 g/mol)?

2. Which of the following solutions has a higher molarity? (circle one) Support your answer with work.

20.0 g of HNO_3 in 100.0 mL of solution or 20.0 g of H_2SO_4 in 100.0 mL of solution

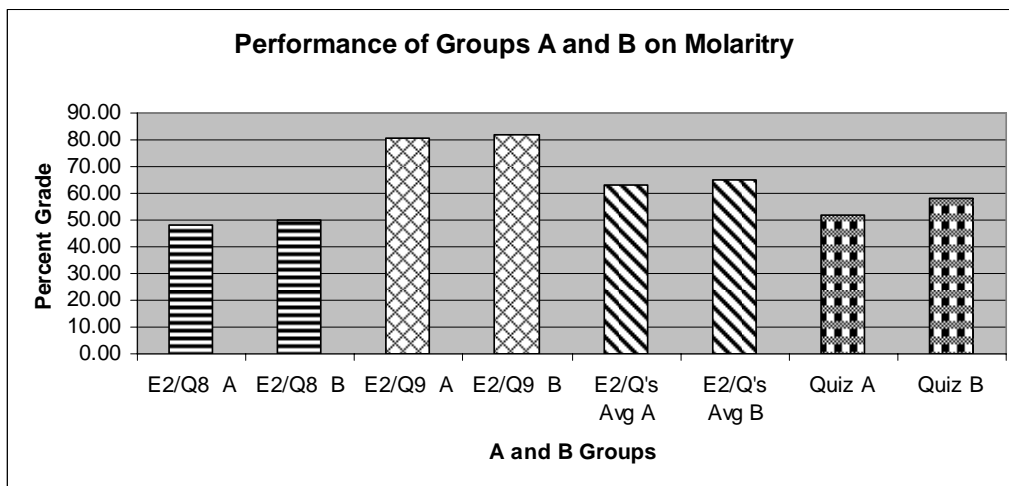

Plot of the students' average score on Exam 2 questions and quiz.

Solution stoichiometry questions used for homework, tutorials, quiz, and Exam 2.

Tutorial

Given the following net ionic equation, write the molecular equation and give the ionic equation:

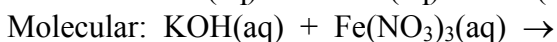
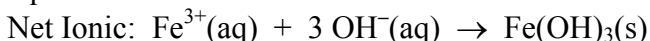

Ionic:

Write the molecular, ionic, and net ionic equations for the following equations:



Ionic:

Net Ionic:

Balance the equation and complete the following picture diagram:

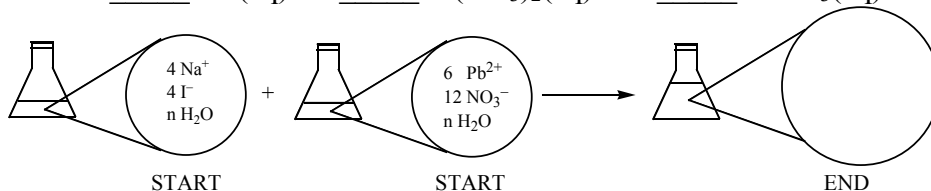
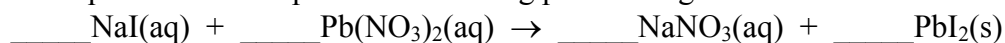

Homework

Write net ionic equation for:

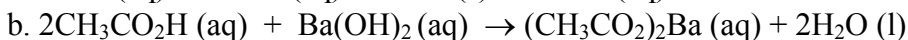
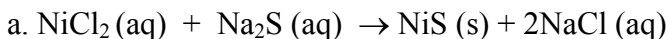

Write balanced ionic equations for the following reactions:

a. Aqueous hydrofluoric acid is neutralized by aqueous calcium hydroxide

b. Aqueous magnesium hydroxide is neutralized by aqueous nitric acid

Quiz

Write the molecular, ionic, and net ionic equations for the reaction that takes place when the following solutions are mixed



Exam 2

1. Identify the following reactions as precipitation, acid-base, or oxidation-reduction by circling the correct response. For parts c, d, and e, write complete (including physical states), balanced molecular, ionic, and net ionic equations.

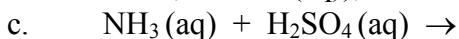

Reaction type: precipitation acid-base oxidation-reduction

Molecular equation:

Ionic equation:

Net ionic equation:

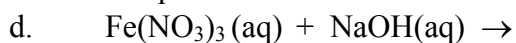

Reaction type: precipitation acid-base oxidation-reduction

Molecular equation:

Ionic equation:

Net ionic equation:

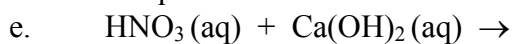

Reaction type: precipitation acid-base oxidation-reduction

Molecular equation:

Ionic equation:

Net ionic equation:

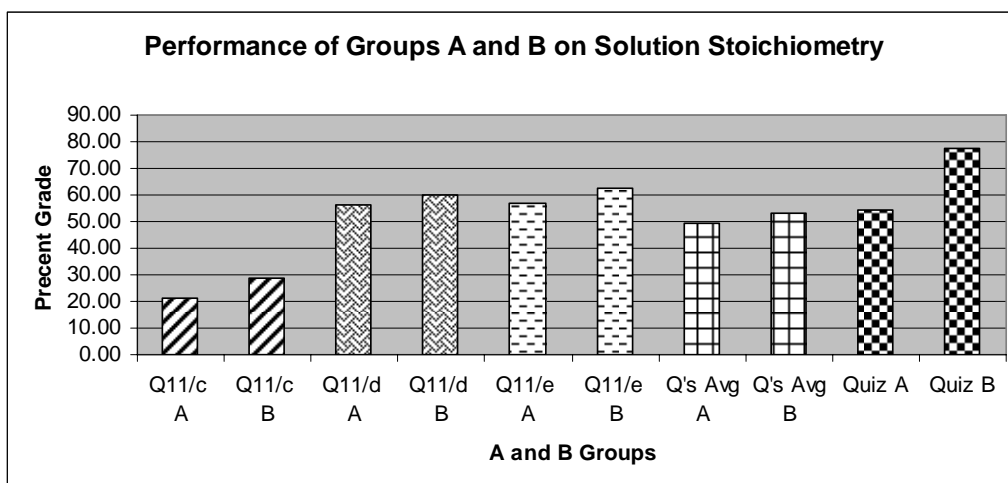

Plot of students' average score on Exam 2 solution stoichiometry question and quiz.

Lewis structures and periodic trends questions used for homework, tutorials, quiz, and Exam 3.

Tutorial

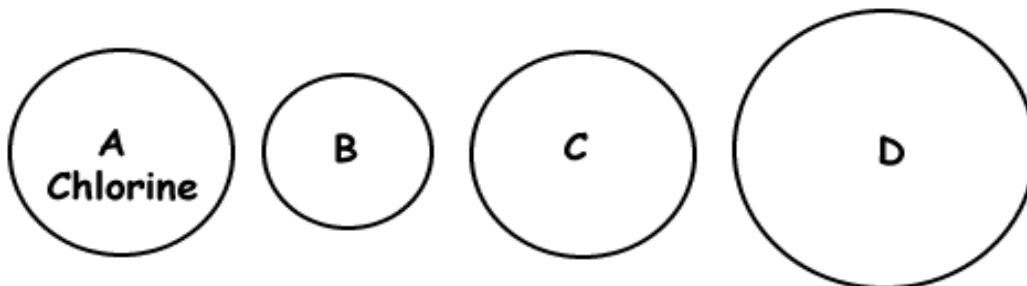

1. Given the representation of a chlorine atom, which circle might represent atom of bromine? Which circle might represent atom of fluorine?
2. Arrange the following elements in the order of increasing electronegativity.
Si, Fe, Rb, Br
3. Which of the following compounds would have the greatest ionic character?
CaCl₂, FeS, CS₂, CO₂
4. Write the electronic configuration for the valence electrons for each of the following elements and ions and draw their Lewis dot structure:
(Students are given a table to fill in)

Homework

Write the electronic configuration of the following atomic numbers $Z=55$, 40, 80, and 62
Draw Lewis dot structure for: SbCl₃, ClO₂, PF₅

Quiz

1. Which of the following has the lowest electronegativity?
C, O, Si, S
2. Consider NCl₃
How many valence electrons are present in NCl₃?
Draw the Lewis structure for NCl₃.

Exam

Which of these elements would have the lowest first ionization energy?

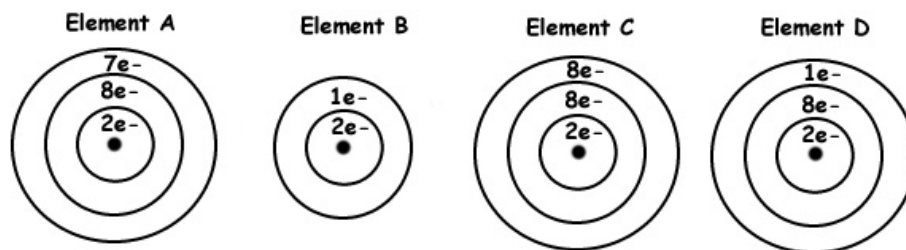

- a) Element A b) Element B
c) Element d) Element D

Which of the following correctly shows the relative electronegativities of the elements?

- a) $B < Li < Cs < Cl < Br < O$ b) $O < Cl < Br < B < Li < Cs$
c) $Cs < Li < B < Cl < Br < O$ d) $Cs < B < Li < Br < Cl < O$
e) $Cs < Li < B < Br < Cl < O$

Draw a Lewis structure for each of the following formulas. Draw all valid resonance structures where resonance is possible.

- a) $COBr_2$ (carbon is the central atom)
b) NO_2^-
c) AsF_6^-

Give the electronic configuration ($1s^2 \dots$) for the following, but do not use the noble gas core notation:

- a) Cr b) Kr c) N^{3-}

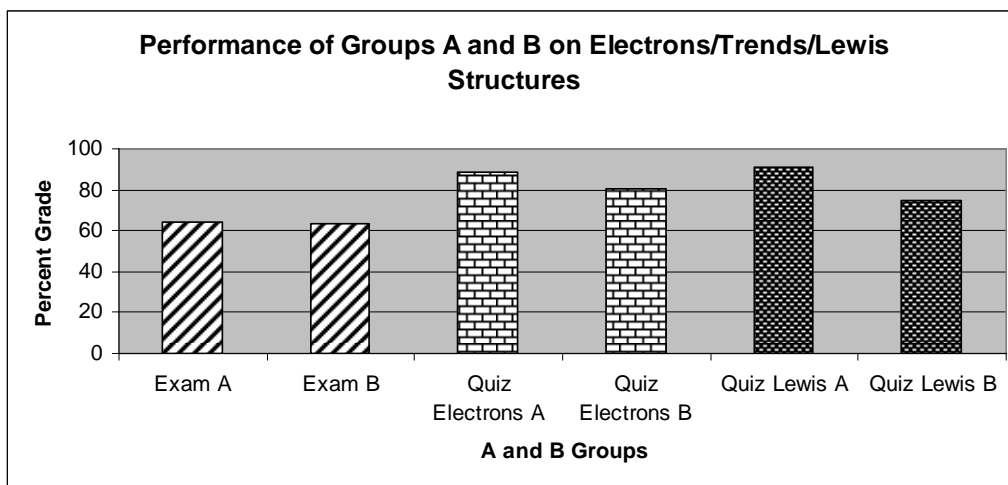

Plot of the students' average score on Exam 3 and two quizzes.

Calorimetry, and gases questions used for homework, tutorials, quiz, and Exam 4.

Tutorial

Calorimetry:

1. A 20.0 mL sample of 0.200 M AgNO_3 at 12.5 °C is mixed with 30.0 mL of a 0.100 M solution of HCl. Write a balanced equation for this reaction. What will the final temperature be? (ΔH° for the reaction is -68 kJ/mol)

2. One beaker contains 200 mL of water at 20°C and a second beaker of 150 mL of water is at 80 °C. Without doing detailed calculations, which of the following is a plausible final temperature after mixing the contents of the two beakers: (28°C, 40°C, 46°C, 50°C). Explain your reasoning.

3. A 100g sample at 20°C absorbs 1.00 kg of heat. Without doing detailed calculations, which metal, aluminum, iron, or silver, will be raised to the highest temperature,? Explain your reasoning.

Tutorial

Gases:

1)

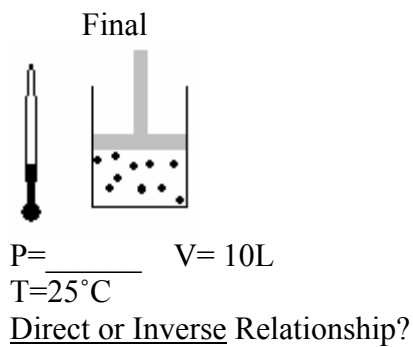
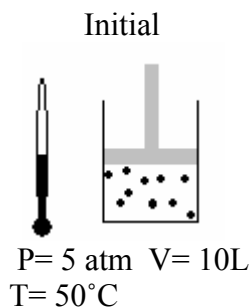

Law _____

2)

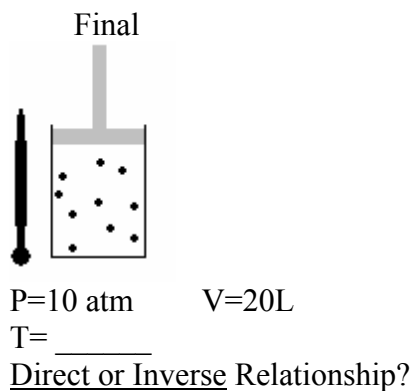
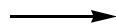
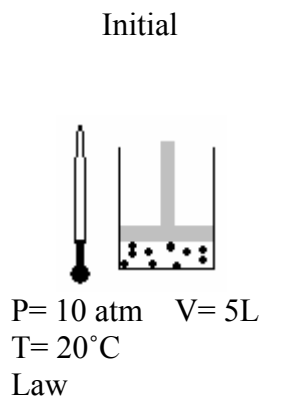

3)

Initial

Final

→

<div style="border: 1px solid black; width: 50px; height: 50px; margin: 0 auto;"></div> <p>P= 10 atm V=2L T= 100°C n=5 mol Law _____</p>	<div style="border: 1px solid black; width: 50px; height: 50px; margin: 0 auto;"></div> <p>P= 20 atm V= _____ T=100°C n=5 mol <u>Direct or Inverse Relationship?</u></p>
--	--

Which of the two gas samples has more molecules: 2.50 L of air at 50°C and 750 mmHg pressure or 2.16 L of CO₂ at - 10°C and 765 mmHg pressure?

Homework

1. A 638-g block of lead was initially at 27.0°C absorbers 2044J of heat. What is the final temp. of lead?
2. A 9.13-g sample of vanadium is heated to 99.10°C and is then dropped into 20.0g water in a calorimeter. The water temperature rises from 20.51 to 24.46°C. Calculate the specific heat of vanadium?
3. A 500.0-mL sample of 0.500M NaOH at 20.00°C is mixed with an equal volume of 0.500M HCl at the same temperature in a plastic-foam cup calorimeter. The reaction takes place, and the temperature rises to 23.21°C. Calculate ΔH° for the reaction.
A compressed air tank carried by scuba divers has a volume of 8.0L and a pressure of 140atm at 20°C. What is the volume of air in the tank in liters at STP?

Quiz

A 325g metal sample is heated from 77C to 102C, upon heating the sample absorbed 1.882KJ of heat. What is the identity of the metal sample?

Specific heat J/g°C	Element
0.449	Fe
0.385	Cu
0.232	Ag
0.128	Au

The specific heat of water is **greater** than that of copper.

A piece of copper metal is put into an insulated calorimeter that is nearly filled with water. The mass of the copper is the **same** as the mass of the water, but the initial temperature of the copper is **higher** than the initial temperature of the water. The calorimeter is left alone for several hours.

During the time it takes for the system to reach equilibrium, will the temperature change (number of degrees Celsius) of the copper be *more than*, *less than*, or *equal* to the temperature change of the water? Please explain your answer.

A gas occupies 5.0L at 735 mm Hg and 27°C. What is the volume at STP?

Exam

Calorimetry:

1. Phileas Fogg, the fictional character who went around the world in 80 days, was very fussy about his bathwater's temperature. It had to be exactly 38.0 °C. You are his butler, and one morning while checking his bathwater's temperature, you notice that it's 42.0 °C. You plan to cool the 100.0 kg of bathwater to the desired temperature by adding an aluminum-ducky originally at freezer temperature (-24.0°C). The specific heat of Al = 0.900 J/g-°C. Assume that the aluminum has no heat loss or gain involving anything except the water.

A. How much heat does the water need to lose to become 38.0 °C? Show your work.

B. What mass of Al is needed to produce the temperature change in the water? Show your work.

2. A 1.55-g sample of CH₄O is burned in a calorimeter that contains 2.0 L of water. Assume that the molar heat of combustion of CH₄O is -725 kJ/mole, and assume that the 2.0 L of water absorbs all of the heat of combustion.

A How much heat does burning the CH₄O produce? Show your work.

B Quantitatively, how does the temperature of the water change? (Indicate both the direction and amount of change.) Show your work.

Gases:

A sample of gas is confined to a cylinder with a movable piston.

Initially, the sample consists of 0.075 mole of gas at 25 °C and 0.92 atm pressure, as depicted in the initial diagram.

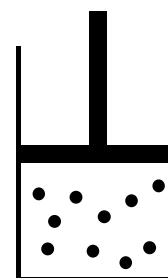

Initial

For each set of final conditions, select the diagram that best represents the appearance of the gas, cylinder, and piston. Then justify your choice by calculating how volume should change from initial to final conditions. For example, if V_{final} is 5.0 times larger than V_{initial} , write 5.0 in the blank.

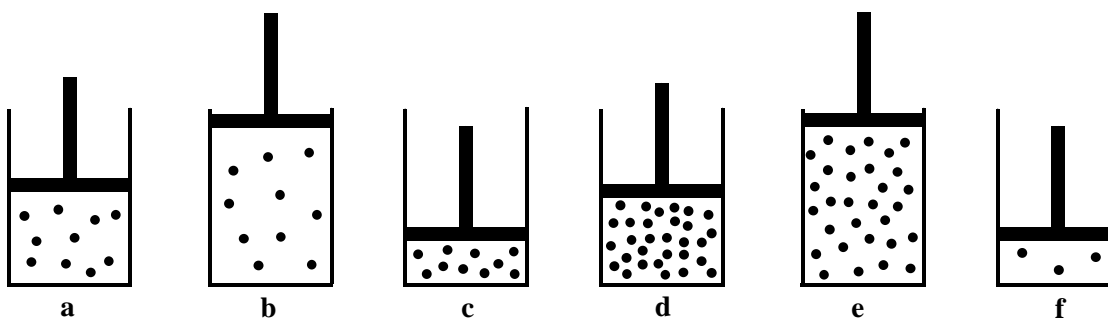

A. Final conditions #1: $T = 50.0\text{ }^{\circ}\text{C}$; $n = 0.075\text{ mol}$; $P = 0.92\text{ atm}$

1. Which diagram best represents the final conditions? **a b c d e f**

2. $V_{\text{final}} = \underline{\hspace{2cm}} \times V_{\text{initial}}$

3. Show your work to justify your answer to part 2.

B. Final conditions #2: $T = 175\text{ }^{\circ}\text{C}$; $n = 0.075\text{ mol}$; $P = 2.7\text{ atm}$

- Which diagram best represents the final conditions? **a b c d e f**
 - $V_{\text{final}} = \underline{\hspace{2cm}} \times V_{\text{initial}}$
 - Show your work to justify your answer to part 2.
- C. Final conditions #3: $T = 25\text{ }^{\circ}\text{C}$; $n = 0.22\text{ mol}$; $P = 2.7\text{ atm}$
- Which diagram best represents the final conditions? **a b c d e f**
 - $V_{\text{final}} = \underline{\hspace{2cm}} \times V_{\text{initial}}$
 - Show your work to justify your answer to part 2.

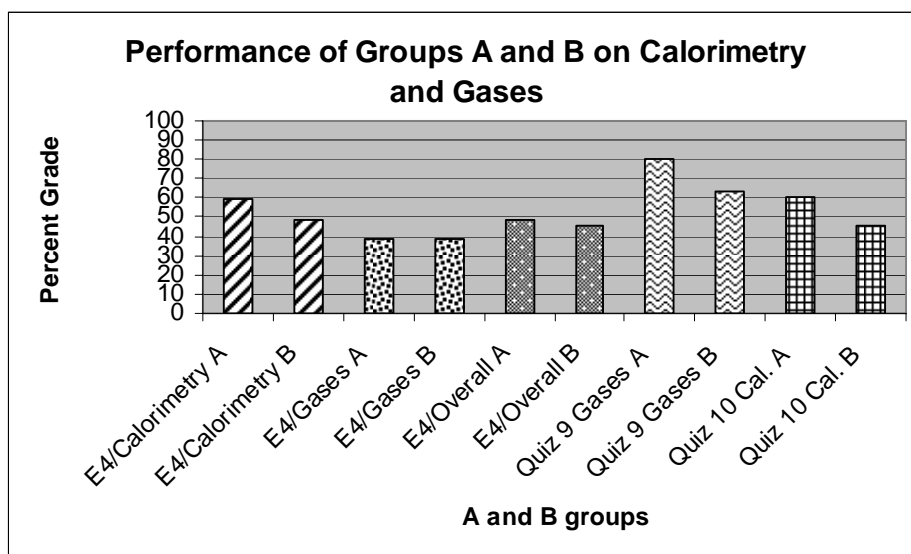

Plot of the students' average score on Exam 4 and the two quizzes.

CHAPTER THREE

MAKING CHEESE USING THE SCIENCE WRITING HEURISTIC APPROACH

Background

Cheese was first made by our ancestors through an accidental event. Milk was left to turn sour as a result of its naturally occurring bacteria. With technological advances cheese can now be made more easily, safely, more efficiently, and with higher quality (1). Milk is rich in a variety of biochemical compounds. It is a mixture of water, fat, protein, sugar and inorganic salts. One component of particular interest is the milk protein casein. Casein under the right conditions, such as low pH or the addition of a protease (an enzyme that breaks casein down), can fall out (precipitate) of the solution. The resulting chunks are called curds and the remaining clear solution is called whey (2).

In this experiment students will be comparing the performance of the addition of three different curdling agents, studying variables such as amount and speed upon which cheese is produced once the agents are added to the milk samples. Students will perform this laboratory activity using an inquiry format. The inquiry format used in this laboratory is the Science Writing Heuristic (SWH) approach. Through a variety of research studies by Greenbowe and coworkers, the SWH approach has been proven to be an effective method to use to conduct laboratory activities (3-10). Using the SWH students are better able to relate their laboratory experiences to scientific concepts of interest rather than conducting the laboratory the traditional way. The students use collaborative learning and engage in discussion to devise laboratory procedures following the SWH format in contrast to performing the laboratory in the traditional way where they tend to follow a cookbook recipe,

finish their assigned tasks, and leave the laboratory as quickly as possible without putting effort into thinking about what they are doing and why (11).

Experimental procedures

The students will use three curdling agents to make cheese: buttermilk, rennin, and chymosin. Buttermilk has a good culture of *Lactobacillus* bacteria and is used to start the curdling process. The selected bacteria make the enzymes that convert lactose to lactic acid that is responsible for the curdling of milk. Purified rennin, an enzyme from the stomach cell lining of a calf, is used. Purified rennin is a protease characterized by its ability to cleave protein milk casein into small fragments that settle out of the solution as curds. Chymosin behaves in the same manner as rennin, since it is genetically engineered rennin. Chymosin is produced through recombinant DNA (rDNA) technologies. In the rDNA process, the DNA code for the cheese-making enzyme gets identified, cut out, and inserted into fungus cells. The fungus cells then read the cow DNA and synthesize the rennin enzyme (12-13).

Student will be given milk and the three different curdling agents. They will divide into groups and design their collaborative experiments. To make sure that their experiment is true, they will have a control milk sample and will run each trial several times. They will need to use 7mL of milk samples for each run and add 250 microliters of each of the curdling agents (buttermilk, rennin, and chymosin). Once a particular agent has been added to the milk, they will incubate it for 15 minutes and will note when curdling starts. Once the curdling process has ceased, they will separate the whey from the curds. The students are responsible for devising ways to make this separation. The last step in the process is to determine the amount of curds produced by the various agents. Here again the students will be responsible for devising a way to accomplish this.

Results and discussion

Students create a table with the variables that they believe they will be collecting. In addition, students calculate data based on their findings. The table that the students draft should include the same features as in Table 1. To help the students analyze their data, the instructor will pose the following questions: How do your results compare with those of your classmates? What can be summarized or deduced from the results collected? Such as the time it took for curdling, the amount of curds produced, and the amount of whey produced. What claim(s) can you make concerning the different agents used to produce cheese? How can the overall class data be put into graph format to show possible trends? Are there any anomalies in your data? What went wrong, if anything? How could you fix it? How would you revise and run the experiment differently?

Table 1. Cheese making data collected and calculated.

Curdling Agent	Time to Curdle (min)	Volume of Whey (mL)	Volume of Curds (mL)	Mass of Curds (g)
Buttermilk Trial#				
Rennin Trial#				
Chymosin Trial#				
Milk (control) Trial#				

Hazards

There are no hazards for this laboratory. However, if the teacher decides to allow the students to taste their products, they need to make sure that all of the glassware and supplies are sterile.

Acknowledgements

I would like to thank Dr. Thomas Greenbowe and Dr. K.A. Burke for their continuous support to me even after I started a position at Northwest Iowa Community college and am no longer with them at the office.

References

1. Jeffery R. Broadbent and James Steele. (2005) *ASM News* Vol. 71, Number 3.
2. Kosikowski, F.V., and V.V. Mistry. (1997). *Cheese and Fermented Milk Foods. Volume 1: Origins and Principle* . 3rd ed. Westport, Conn.: F.V. Kosikowski.
3. Hand, B.; Keys, C.W. (1999) *Sci. Teach* 66, 27-29.
4. Keys, C.W.; Hand, B.; Prain, B; Collins, S. (1999). *J. Res. Sci. Teach.*36, 1065-1084.
5. Keys, C.W. (1999) *Sci. Educ.* 83, 115-130.
6. Rudd, J.A.; Greenbowe, T.J.; Hand, B.M. (2001) *J. Coll. Sci. Teach.* 31, 230-234.
7. Hand, B.; Prain, V. (2002) *Sci. Educ.* 86, 737-755.
8. Wallace, C.S.; Hand, B. Using the Science Writing Heuristic to Promote Learning from Laboratory. In Wallace, C.S., Hand, B., Prain, V. (Eds.), *Writing and Learning in the Science Classroom*. Kluwer: Boston, MA, 2004.
9. Poock, J.R. Investigating the Effectiveness of Implementing the Science Writing Heuristic on Student Performance in General Chemistry. Unpublished Ph.D. Dissertation, Iowa State University, Ames, IA, USA, 2005.
10. Burke, K.A.; Greenbowe, T.J.; Hand, B.M. "Implementing the Science Writing Heuristic in the General Chemistry Laboratory." *J. Chem. Educ.* (accepted).
11. Greenbowe, T.J., & Hand B. (2005). Introduction to the Science Writing Heuristic. In N. Pienta, M. Cooper, T.J. Greenbowe (Eds.) *Chemists' Guide to Effective Teaching* (pp. 140-154). Upper Saddle River, NJ: Prentice-Hall.
12. Ellyn Daugherty (2007). *Biotechnology science for the new millennium*. (pp. 3-19, 209-210, 216-217). Paradigm Publishing. St.Paul, MN.
13. Ellyn Daugherty (2007). *Biotechnology lab manual*. (pp. 6-12). Paradigm publishing. St.Paul, MN.

Supplemental materials

Teacher's information

Materials:

Test Tubes, sterile mL	Pipet, 1mL	Graduated cylinder, 25
Pipet, 10 mL	Buttermilk	Funnels
Pipet bulb	Whole milk	Filter paper
Rennin bovine	Chymosin, recombinant rennin	Incubator
Micropipet, P-1000	Test tube racks	Spatulas
Micropipet tips for P-1000	Balances	Oven

Procedures:

1. With a 10-mL pipet, transfer 7 mL of milk into labeled test tubes.
2. Using P-1000 micropipet, add 0.25 mL of one of the three curdling agents to the 7-mL milk sample.
3. Cap the tube and mix gently inverting three times. Record the starting time.
4. Place samples in the incubator for at least 15 minutes.
5. Check for curdling every 5 minutes, recording the time to curdle in minutes.
6. Measure the volume of whey (liquid).
7. Weigh your filter paper before
8. Filter the curds
9. Place filter paper with curds in the oven to dry
10. Weight after
11. Subtract to get the mass of the curds

NOTE:

Chymosin produces the most amounts of curds in the shortest amount of time. Using rennin takes more time for curdling to occur. Using buttermilk takes the most amount of time for curdling. There should be nothing happening with the untouched milk sample because it is a control (12-13).

CHAPTER FOUR
COMPARISON OF STUDENT PERFORMANCE BETWEEN A HIGH AND A LOW
SCIENCE WRITING HEURISTIC LABORATORY SECTION

Introduction

Reviews of research on laboratory instruction (1-3) have indicated that there is a need for more effective laboratory instruction. The National Research Council has also found a need for more effective laboratory instructions and for the incorporation of inquiry teaching strategies into science curricula at all levels of instruction. Students were following the procedures given to them, performing the laboratory and leaving. Not much learning was taking place (4-7).

Recent studies have shown the Science Writing Heuristic (SWH) inquiry-based approach to laboratory activities has the potential to improve laboratory instruction. The SWH approach employs the use of inquiry strategies and writing to learn in order to promote students' critical thinking about scientific concepts. The writing component of the SWH approach is essential to learning chemistry; studies show that students who write regularly learn better and perform better on future writing tasks. The SWH studies to date have not explored in-depth how the writing in the SWH laboratory notebooks influences student understanding of chemistry. (8-16).

In order to address the need for exploring the effect that SWH-oriented laboratory setting have on students, a pilot study was conducted in a general chemistry course for majors in horticulture, forestry, exercise science, meteorology, etc. at a major university in Iowa. This longitudinal study followed the performance of students enrolled in two

laboratory sections throughout a semester. Instructor facilitation (pre-laboratory and post-laboratory discussions) in both laboratory sections followed the SWH approach. However, in one section, the instructor was better able to implement inquiry and the SWH approach compared to the other laboratory instructor. The improved implementation of inquiry and the SWH approach was due to better teaching assistant facilitation as well as enhanced student engagement.

Studies by Tien (17), Rickey (18), and Tien, Rickey, and Stacy (19, 20), demonstrate that a connection exists between effective chemistry laboratory teaching, learning, and improved student performance on lecture examinations. These studies provide an indication that even when that laboratory activity is written in an inquiry format, if the teaching and learning does not include inquiry, then improved student performance on lecture examinations does not take place. Studies by Greenbowe and Hand also demonstrated that students who effectively implement the SWH approach perform better on chemistry examinations compared to students in a less-effective inquiry laboratory setting with less effective instructors (10). Using the SWH in the chemistry laboratory helps students learn chemistry.

The purpose of this pilot study was to determine whether there was a difference in student performance on the laboratory reports and in student performance on the laboratory practical exams, based upon the degree of implementation of inquiry.

Experimental design

Two laboratory sections (A and B) were chosen for the study. Section A (high) had better implementation of the SWH approach compared to section B (low). The two sections were labeled as high and low according to their degree of implementation of the SWH

approach based on the observations of chemical educators who are familiar with inquiry learning strategies. The study involved seven students from each of the laboratory sections. The decision to choose seven students was determined by the students' performance on the first two lecture exams. There were approximately twenty students in each of the two laboratory sections and only seven of the twenty students enrolled in each of the two sections achieved similar scores on the first two lecture exams. Therefore, only seven of the students in each section could be included in the study since there were no statistical differences between their chemistry knowledge and performance on exams 1 and 2 of the lecture portion of the course.

The study investigated two factors. The first component was the students' progress throughout the semester on their ability to write complete SWH laboratory reports. Evaluation of the quality of the students' reports (based on a grading rubric) was done by graduate students in the chemical education area. The laboratory reports were evaluated by two chemical educator researchers based on seven criteria shown in Table 1. The second factor involved a comparison of the performance of students on a laboratory report and an equivalent laboratory practical exam task. Table 2 shows a chart of the two groups and the laboratory activities studied.

Research question

The Research questions are: do students who have better SWH laboratory implementation have better laboratory reports scores as compared to students in a low implementation laboratory section, and do the students with better SWH laboratory implementation have better performance on laboratory practical exam tasks as compared to students in a low implementation laboratory section?

Results and discussion

The first component of this study is the analysis of the laboratory reports of the seven students in laboratory section A. Figure 1 shows each student's progress starting at the first laboratory through the eighth via a plot of raw score on the laboratory report vs. the identity of the laboratory activity. Table 3 displays a regression analysis of the scores of the seven students on the eight laboratory reports. Most of the laboratory reports in section A have a high correlation with the increased scores on their laboratory reports as the semester progressed or as they went from laboratory number one to laboratory number eight. The seven students improved their laboratory reports scores as the semester progresses. The correlation for section A was acceptable since the average R^2 value was greater than 0.5.

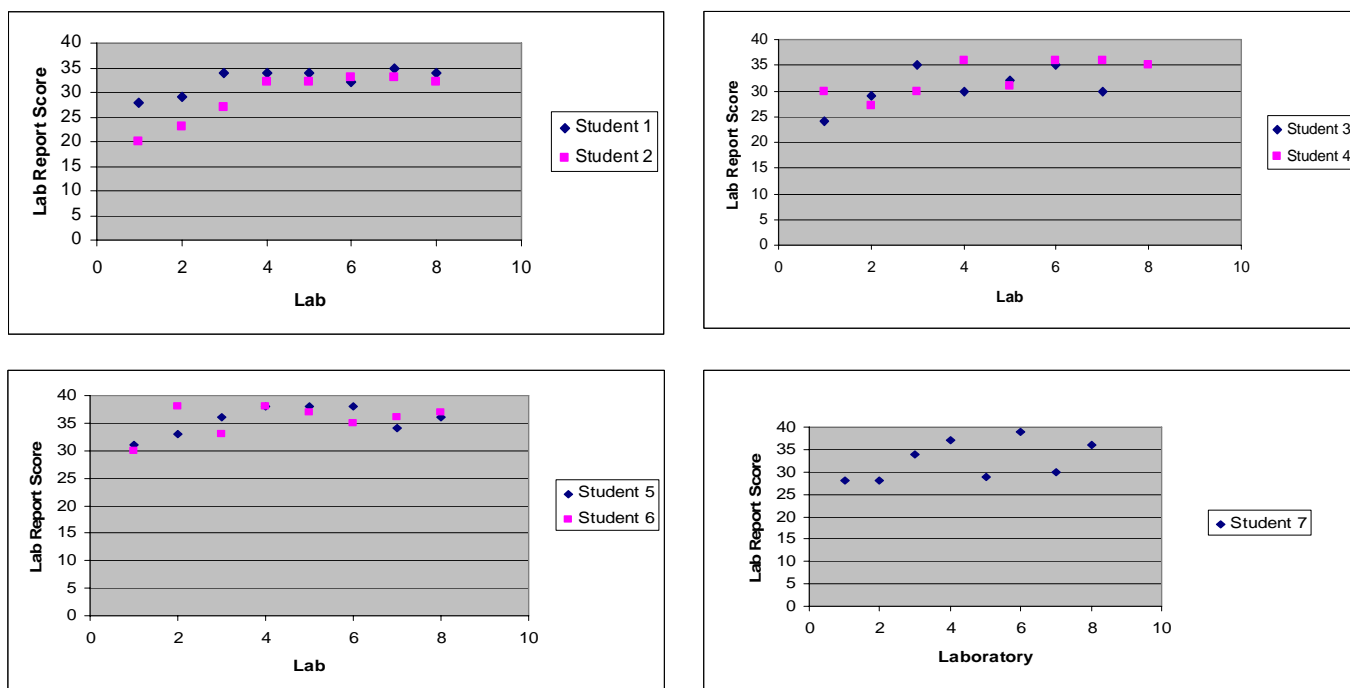

Figure 1. The seven students from Section A laboratory. Their raw scores on each laboratory experiment are plotted against the experiment number.

Table 3. Regression analysis of raw report scores for the seven students in laboratory section A

Student 1	$y=0.7857x+28.964$
	$R^2=0.5402$
Student 2	$y=1.8095x+20.857$
	$R^2=0.7640$
Student 3	$y=0.9643x+26.857$
	$R^2=0.2978$
Student 4	$y=1.1071x+27.643$
	$R^2=0.5859$
Student 5	$y=0.5476x+33.036$
	$R^2=0.2624$
Student 6	$y=-0.5238x+33.143$
	$R^2=0.2134$
Student 7	$y=0.869x+28.714$
	$R^2=0.2335$

Laboratory report scores from the seven students in laboratory section B, the low SWH implementation section, do not show progress from the first through the eighth laboratory. Figures 2 show that each of the students' laboratory performances are scattered all over the graph. Their raw scores fluctuate with no particular trend. Table 4 shows the regression analysis of the seven students on the eight laboratory reports. The table shows the lack of correlation between the progression of the semester and the students' laboratory report scores.

When looking at the average laboratory report scores for all of the students in section A compared to all of the students on section B, instead of individual student comparisons, the trends observed still hold. The seven section A students' average scores still show that linear positive correlation Section A (High) $Y=0.899x+28.58$ and $R^2=0.612$. This correlation does not hold for the seven section B (low) student $Y=0.049x+27.87$ and $R^2=0.0018$. Figure 3 show that correlation for both laboratory sections.

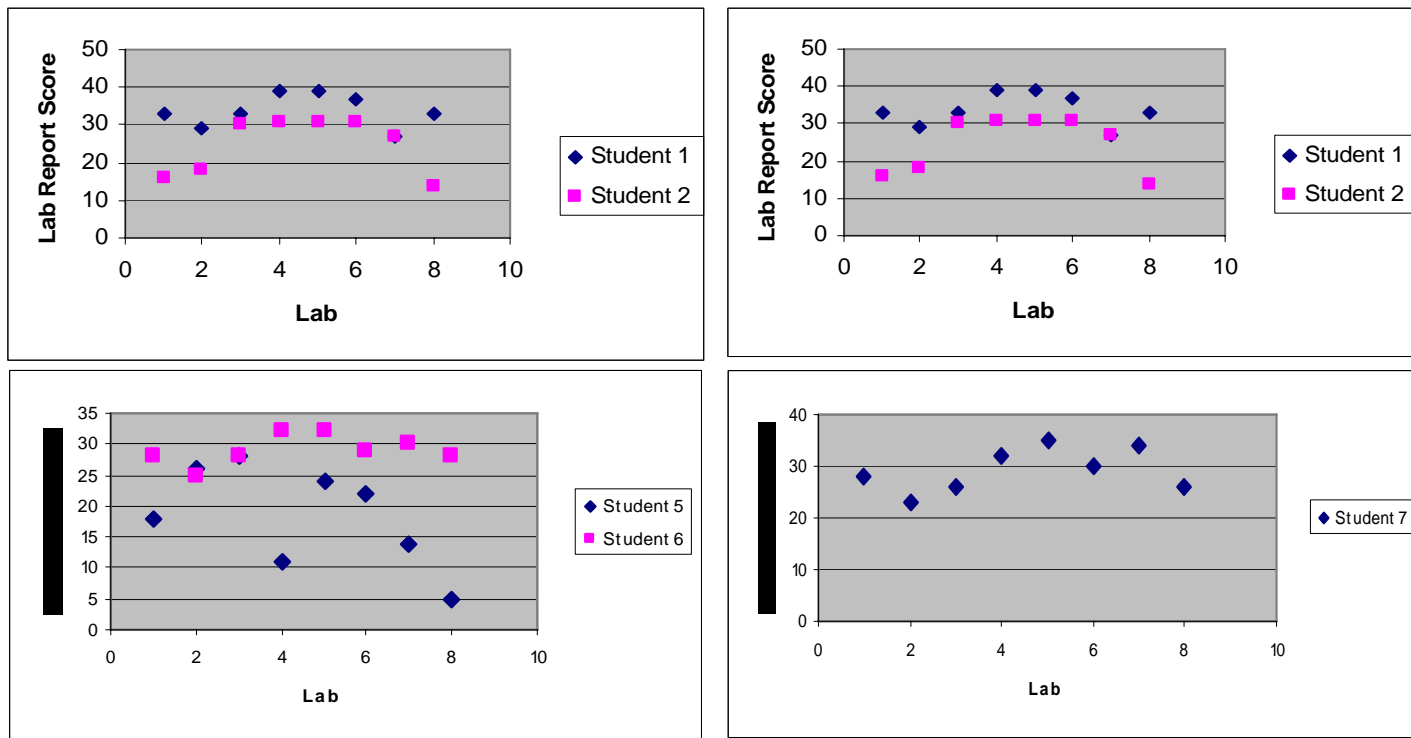

Figure 2. The seven students from laboratory section B. Their raw scores on each laboratory experiment are plotted against the experiment number.

Table 4. Regression analysis of raw report scores for the seven students in laboratory section B

Student 1	$y=0.0238x+33.643$
	$R^2=0.0002$
Student 2	$y=0.4048x+22.929$
	$R^2=0.0178$
Student 3	$y=0.5x+25.5$
	$R^2=0.1556$
Student 4	$y=0.2738x+31.393$
	$R^2=0.0199$
Student 5	$y=-1.8571x+26.857$
	$R^2=0.3233$
Student 6	$Y=0.3333x+27.5$
	$R^2=0.1228$
Student 7	$y=0.6667+26.25$
	$R^2=0.14887$

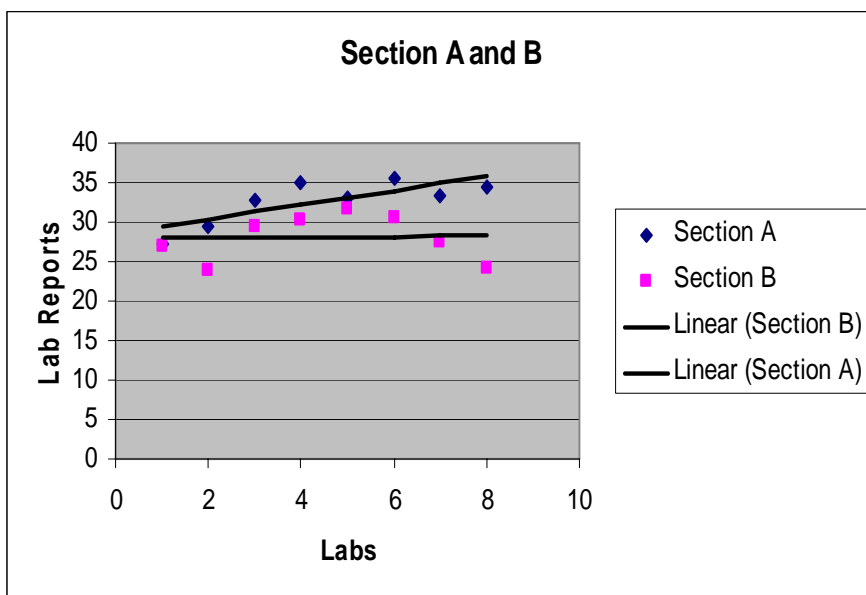

Figure 3. The trend in laboratory report progress for the average student scores of both sections A and B. The eight average laboratories scores plotted against the number of the laboratory report

The second component of this pilot study investigated the students' performance on two separate laboratory activities, the analysis of hydrates and the identity of an unknown chemical compound, as compared to comparable laboratory practical exam tasks. The percent scores of the students' laboratory reports in both sections were compared to percent scores for the comparable tasks on the corresponding laboratory practical exam. Report scores for Section A students correlated better on the hydrated salts laboratory than did report scores for Section B students (section A $R^2=0.4842$, section B $R^2=0.1163$). However, students in both sections achieved comparable results on the identity of a chemical reactant laboratory (section A $R^2=0.3479$, section B $R^2=0.3142$). Figure 4 shows this comparison.

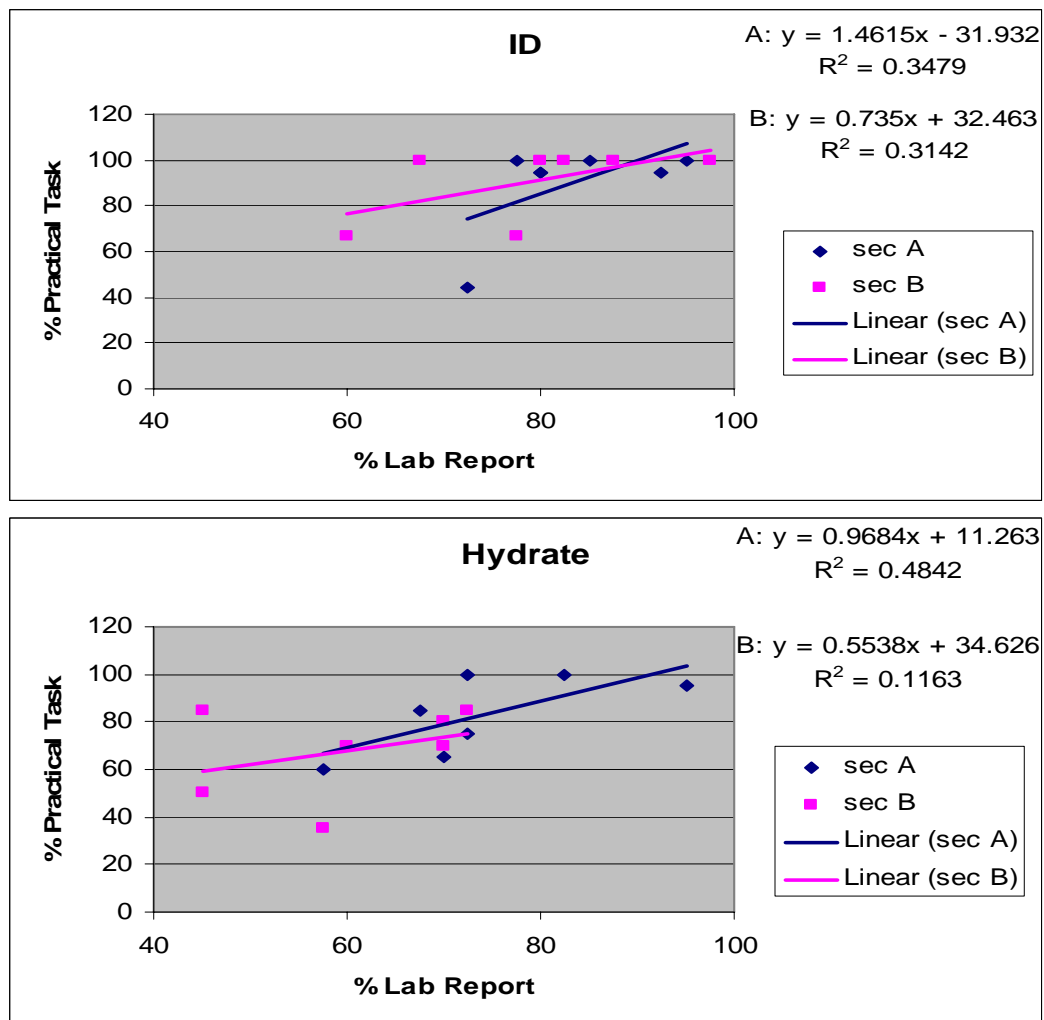

Figure 4. The trend in average percent laboratory report score compared to the average percent scores for the particular practical exam task for section A and section B students.

In order to better compare these findings, a Chi Square (χ^2) test was performed (21, 22). The Chi Square test compares expected and observed values. It tests for whether expected (E) and observed (O) values are dependent or independent of each other. The

equation for the Chi square calculation is: $\chi^2 = \sum (O-E)^2/E$. since there were eight laboratories, there are 7 degrees of freedom set at $\alpha=0.05$. Chi square tables for these parameters give $\chi^2=14.1$. From the calculations, χ^2 for section A=12.3, $P(A) = 0.0911$ and χ^2 for section B=29.8, $P(B) = 0.0001$. Therefore, there are significant differences between the two sections. Tables 5 and 6 show the Chi Square results for both laboratory sections.

Table 5. Chi Square analysis of the laboratories of section A students

Labs	Observed	Expected	O-E	(O-E)sq	O-E sq/E
1	27.29	40	-12.71	161.5	4.04
2	29.57	40	-10.43	108.8	2.72
3	32.71	40	-7.29	53.1	1.33
4	35	40	-5	25	0.63
5	33.14	40	-6.86	47.05	1.18
6	35.43	40	-4.57	20.88	0.52
7	33.43	40	-6.57	43.16	1.08
8	34.43	40	-5.57	31.02	0.77
Sum	261	320	-59	490.6	12.3

Table 6. Chi Square analysis of the laboratories of section B students

Labs	Observed	Expected	O-E	(O-E)sq	O-E sq/E
1	26.86	40	-13.14	172.6	4.32
2	24	40	-16	256	6.4
3	29.57	40	-10.43	108.8	2.72
4	30.29	40	-9.71	94.28	2.36
5	31.57	40	-8.43	71.1	1.77
6	30.57	40	-9.43	88.9	2.22
7	27.57	40	-12.43	154.5	3.86
8	24.29	40	-15.71	246.8	6.17
Sum	224.7	320	-95.28	1193	29.8

Conclusion

The results discussed above suggest that good implementation of the SWH format helps the students' performance on their laboratory reports as well as similar laboratory practical exam tasks. When the implementation of the SWH is well done, the instructor or the teaching assistant acts only as a facilitator, helps direct the students' questions back to the student groups, and encourages group collaborations. Students in a well-implemented SWH approach inquiry-based laboratory setting are always engaged discussing data, claims, and evidence. These behaviors are exactly what were observed during section A laboratory sessions.

The results observed with this study are consistent with previous research regarding the SWH approach. The various SWH research studies found a connection between good implementation of the SWH from both the students and the instructor with improved examination scores (8-12, 23-29).

The SWH approach, especially the use of the student rubric template as the laboratory report format, provides guidance to the students on how to learn in an inquiry environment. The SWH approach increases students' ability to propose questions to investigate, to design experiments to answer their questions, to relate laboratory activities and observations to science concepts, and to increase their understandings by writing scientific knowledge claims supported by experimental evidence. In addition, the last section of the report titled reading and reflections, helps refine students' knowledge and understanding. Using the SWH, students can explain via their writing what their understanding is of the concepts being investigated in the laboratory activity. This research study provides evidence that the SWH approach is an effective inquiry-based strategy. The more effectively the instructor

implemented the SWH approach, the more engaged and involved his or her students will be. The more engaged students are during a laboratory activity, the more their performance on the laboratory practical tasks will increase as well as their understanding of chemistry.

References

1. Domin, D. S. (1999) *J. Chem. Educ.* 76, 543-547.
2. Lazarowitz, R.; Tamir, P. In *Handbook of Research on Science Teaching and Learning*, Gabel, D., Ed.; Macmillan: New York, 1994; pp 94-128.
3. Hofstein, A.; Lunetta, V. N. (1982) *Rev. Ed. Res.* 52, 201-207.
4. National Research Council. *National Science Education Standards*; National Academy Press: Washington, DC, 1996.
5. Pavelich, M. J.; Abraham, M. R. (1979) *J. Chem. Educ.*, 56, 100-103.
6. Allen, J. B.; Barker, L. N.; Ramsden, J. H. (1986) *J. Chem. Educ.* 63, 533-534.
7. Tobin, K. (1990) *School Sci. Math.* 90, 403-418.
8. Keys, C.W.; Hand, B.; Prain, V.; Collins, S. (1999) *J. Res. Sci. Teach.* 36, 1065-1081.
9. Hand, B.; Keys, C.W. (1999) *Sci. Teach.* 66, 27-29.
10. Greenbowe, T.J.; Hand, B.M. (2005). "Using the Science Writing Heuristic to Improve Students' Understanding of Chemistry." In Chemists' Guide to Effective Teaching. N. Pienta, T. Greenbowe, M. Copper (Eds.). Prentice-Hall: Upper Saddle River, NJ.
11. Jason R. Poock, K.A. Burke, Thomas J. Greenbowe, and Brian M. Hand (2007) *JCE*. 84, 1371.
12. Burke, K.A, Greenbowe, Thomas, J, Hand, Brian M. (2006). *JCE*, 83, 1032.
13. Kovac, J., & Sherwood, D. W. (1999). Writing in chemistry: An effective learning tool. *Journal of Chemical Education*, 76, 1399-1403.
14. Lawson, A. E. (1995). *Science teaching and the development of thinking*. Belmont, CA: Wadsworth Publishing Company.

15. Lazarowitz, R., & Tamir, P. (1994). Research on using laboratory instruction in science. In D. L. Gabel (Ed.), *Handbook of Research on Science Teaching and Learning* (pp. 94-128). New York: MacMillan.
16. Lloyd, B.W. (1992). The 20th century general chemistry laboratory: Its various faces. *Journal of Chemical Education*, 69, 866-869.
17. Tien, L.T. Fostering Expert Inquiry Skills and Beliefs about Chemistry through the MORE Laboratory Experience. Unpublished doctoral dissertation, University of California-Berkeley, Berkeley, CA, 1998; UMI Microform # 9902256.
18. Rickey, D. K. The Effects of Laboratory Curriculum and Instruction on Undergraduate Students' Understanding of Chemistry. Unpublished doctoral dissertation, University of California-Berkeley, Berkeley, CA, 1999; UMI Microform #9966547.
19. Tien, L. T.; Rickey, D.; Stacy, A. M. (1999). *J. Coll. Sci. Teach.* 28, 318-324.
20. Stacy, A.M. The Graduate Student in the Dual Role of Student and Teacher. In *Graduate Education in the Chemical Sciences: Issues for the 21st Century: Report of a Workshop*. National Academy of Sciences: Washington, D. C, 2003.
21. Larson. Ron and Farber. B. *Elementary Statistics. Picturing the world*. Prentice Hall 2000.
22. Moore, D. S. *The Basic Practice of Statistics, 2nd ed.*, W. H. Freeman and Company, New York, 2000.
23. Hand, B.M. Cognitive, Constructivist Mechanisms for Learning Science Through Writing. In *Writing and Learning in the Science Classroom*. C. Wallace; B. Hand; Prain, Eds.; Dordrecht, the Netherlands: Kluwer Academic Publishers, 2004.
24. Hand, B.; Keys. C.W. (1999). Inquiry investigation: A new approach to Laboratory Reports. *Sci. Teach.* 66, 27-29.
25. Hand, B.M.; Prain, V.; Lawrence, C.; Yore, L. (1999). A Writing in Science Framework Designed to Enhance Science Literacy. *Intl. J. Sci. Educ.* 10, 1021-1036.
26. Keys, C.W.; Hand, B.; Prain, V.; Collins. S. (1999). Using the Science Writing Heuristic as a Tool for Learning from Laboratory Investigations in Secondary Science. *J. Res. Sci. Teach.* 36, 1065-1084.
27. Prain, V.; Hand, B.M. (1996). Writing for Learning in Secondary Science: Rethinking Practices. *Teach. and Teacher Educ.* 12, 609-626.

28. Rudd, J.; Greenbowe, T.; Hand, B. (2001). Reshaping the general chemistry laboratory report using the science writing heuristic. *J. Coll. Sci. Teach.*31, 230-234.
29. Rudd, J.; Greenbowe, T.; Hand, B.; Legg, M. (2001). Using the Science Writing Heuristic to move toward an inquiry-based laboratory curriculum: An example from physical equilibrium. *J. Chem. Educ.*78, 1680-1686.

CHAPTER FIVE

OVERALL CONCLUSIONS

In the two studies discussed in this thesis, an inquiry approach was used in place of a traditional or standard approach for college level general chemistry recitation and laboratory sections. In both settings, the results of the analysis of the data indicated that the SWH approach inquiry students did better compared to the students using a standard or traditional approach on several measures of chemistry content knowledge. The results of this experiment indicate that a student-centered learning environment creates an essential component in helping students learn chemistry. Moreover, the interaction between the instructor and the students adds to the learning value for students. In addition to the inquiry strategies, the Science Writing Heuristic used in the academic chemistry laboratory adds a powerful writing component that enhances the students' learning experiences. The SWH provides the students with opportunities to collaborate on performing laboratory tasks, discussing and analyzing data, suggesting claims, and offering evidence to support their claims. In addition to the student-centered environment that the SWH creates, the SWH provides the students with a valuable writing component which allows the students to go back and reflect on the experiment performed and establish a connection between the laboratory and the lecture portion of their course.

The tutorial study investigated the power of inquiry strategies in the recitation component of a large course. Students using the tutorials collaborated in small groups to work through the problems. Student collaboration (with facilitation by the instructor) helped individuals learn concepts and develop better problem-solving skills compared to students in

recitation sections working alone or in groups on solving problems (without instructor help) or taking notes on the problems as the instructor wrote the complete solution on the chalkboard.

The SWH approach was used in an introductory biotechnology course to rewrite laboratories in an inquiry-based format. Chapter 3 of this thesis focused on implementing the approach for one particular biotechnology laboratory. This laboratory activity helped students to make cheese via various methods. Previously, students had performed this laboratory following a more traditional cookbook approach. With the SWH inquiry format, however, the students gained better understanding of making cheese using various biotechnology techniques.

The SWH was also used in a general chemistry laboratory component of a general chemistry course for majors in horticulture, forestry, exercise science, meteorology, etc.. Two sections out of 18 were studied. One laboratory section had an instructor who was able to implement SWH better than the other instructor. In the SWH section, the instructor served as only a guide, encouraged students to collaborate with each other on their laboratory tasks, and re-directed questions students had back to their groups. Students in this laboratory section were engaged while working in small groups, discussing and analyzing data, making claims, and supporting their claims with evidence. Students in the other section were not engaged. The student groups in the low section were not discussing and analyzing data effectively due to a less student-centered facilitation by the teaching assistant.

Chapter 4 focused on studying several students from each laboratory section during an entire semester. The students from the high SWH implementation laboratory section produced better laboratory reports than the low SWH implementation section. The high

SWH section also performed better on practical exam tasks that were comparable to laboratory activities performed. The better performance on laboratory reports and laboratory practical examination tasks was due to better student-centered environment made possible by the proper facilitation by the teaching assistant.

Overall, the studies in this thesis found that the Science Writing Heuristic helped students learn chemistry whether the students were in a lecture or a laboratory portion of a science course.

The three studies performed were connected to each other. In fact, one study led to the next. Starting with the pilot study, where an observed high implementation SWH laboratory was compared to an observed low implementation SWH laboratory, the need was identified to expand the study to more SWH laboratory sections as well as bring inquiry and the SWH approach to the recitation. This led to the tutorial study. Both studies were conducted at large universities. Expanding the inquiry and the SWH teaching format to a community college to help students learn science better, led to the biotechnology laboratory modification study.

The implementation of inquiry and the SWH approach in a community college science curriculum is a process that is still at an early stage. Future work would include not only re-writing science laboratory activities to be more inquiry-oriented and specifically follow the SWH format, but also collecting data to support the claim that the students are learning science concepts better. Moreover, expanding the inquiry studies to other community colleges would help researchers to learn more about the data collected, and determine whether data collected continues to support the trend that the SWH approach benefits student academic achievement. Ideas for future research studies include carrying out

a comprehensive study on general chemistry courses at Northwest Iowa and Marshalltown community colleges. The study will include conducting the laboratories at both colleges using the SWH approach and collecting data on exams, laboratory reports, and practical exams in order to see whether the trend for improved exam scores still hold in the mostly nontraditional student community college setting.