



*The Society for engineering
in agricultural, food, and
biological systems*

This is not a peer-reviewed article.

**Paper Number: 022144
An ASAE Meeting Presentation**

Using Lysimeters and Tile Drained Field Plots to Study the Leaching of Field Applied Poultry Manure and UAN into Tile Water

Melissa Cheatham

Department of Ag. and Biosystems Engineering, Iowa State University, Ames, Iowa 50010,
cheatham@iastate.edu.

Ramesh Kanwar, Department Head

Department of Ag. and Biosystems Engineering, Iowa State University, Ames, Iowa 50010.

Jeff Lorimor, Associate Professor

Department of Ag. and Biosystems Engineering, Iowa State University, Ames, Iowa 50010.

Hongwei Xin, Associate Professor

Department of Ag. and Biosystems Engineering, Iowa State University, Ames, Iowa 50010.

Carl Pederson, Research Associate

Department of Ag. and Biosystems Engineering, Iowa State University, Ames, Iowa 50010.

**Written for presentation at the
2002 ASAE Annual International Meeting / CIGR XVth World Congress
Sponsored by ASAE and CIGR
Hyatt Regency Chicago
Chicago, Illinois, USA
July 28-July 31, 2002**

Abstract. Six lysimeters and eleven tile drained field plots were used to determine if the amount of contaminants leaching into tile water would increase after the application of poultry manure and urea

The authors are solely responsible for the content of this technical presentation. The technical presentation does not necessarily reflect the official position of the American Society of Agricultural Engineers (ASAE), and its printing and distribution does not constitute an endorsement of views which may be expressed. Technical presentations are not subject to the formal peer review process by ASAE editorial committees; therefore, they are not to be presented as refereed publications. Citation of this work should state that it is from an ASAE meeting paper. EXAMPLE: Author's Last Name, Initials. 2002. Title of Presentation. ASAE Meeting Paper No. 02xxxx. St. Joseph, Mich.: ASAE. For information about securing permission to reprint or reproduce a technical presentation, please contact ASAE at hq@asae.org or 616-429-0300 (2950 Niles Road, St. Joseph, MI 49085-9659 USA).

ammonium nitrate fertilizer (UAN). There were three nitrogen based treatments applied to the lysimeters and fields: 168 kg N/ha of UAN, 168 kg N/ha of poultry manure, and 336 kg N/ha of poultry manure. (One treatment per lysimeter/field plot.) Corn was planted in the lysimeters and field plots, as well as soybeans in the field plots, in order to simulate field conditions. Tile water samples were collected once a week and after rain events and tested for nitrate, total phosphate, orthophosphate, E. coli, and total coliform. Results thus far indicate that larger amounts of manure/fertilizer applied to lysimeters/field plots appear to predispose the lysimeters and field plot soils to greater contaminate leaching potential. E. coli, total coliform, and total phosphate leaching increased when heavy rain events occurred, while nitrate and orthophosphate leaching decreased.

Keywords. lysimeter, tile drains, E. coli, total coliform, nitrate, orthophosphate, total phosphate, poultry manure, urea ammonium nitrate (UAN)

Introduction

The poultry industry is a vast component of agriculture providing meat such as turkey and chicken, as well as, eggs from layer hens. Egg production in particular continues to grow each year, with Iowa currently being one of the top ten egg producing states according to the Iowa Egg Council (2002). Iowa has about 36 million layer hens, producing around 8.5 billion eggs each year. With so many layer hen needed to produce such vast quantities of eggs, an equally vast quantity of waste is generated, particularly manure. One of the most common methods of utilizing this waste is to apply it to fields to help increase soil fertility leading to increased crop yields. This leads to the question of when does the amount of manure applied while leading to high yields cause excessive contaminate runoff and leaching. Is there a balance that can be achieved where yields are high while keeping contaminate levels in runoff and leaching comparatively low.

Such questions lead to the implementation of best management practices such as crop nutrient management, conservation tillage, erosion and sediment control, and animal feeding operations management, to name a few. (EPA, 2001) Crop nutrient management allows for the application of nutrients to the soil at a rate conducive of good yields yet low enough to keep high nutrients levels from ending up in surface waters. But what application rates work best, and does using a commercial fertilizer or manure give better yields and nutrient management results.

According to Chinkuyu et al., (2002), "...application of hen manure at a low rate of 168 kg N/ha can result in higher crop yields and minimal water pollution in comparison with the same amount of UAN fertilizer or higher manure application rate." Also, Vanlauwe (2001) concluded that organic materials rather than commercial fertilizers helped to improve efficient use of nitrogen by plants because other nutrients that plants may need are also present.

The objective of this study is to determine the impact of poultry manure versus UAN applications on tile water quality and runoff water quality. Nitrate, phosphorus (total and ortho-) and bacteria levels will be analyzed, as well as, soil nutrient levels (before application and after harvest), crop yields, grain quality, and corn stalk N levels.

This research is the continuation of the research conducted by Chinkuyu, et al. (2002) in 1998 through 2000, which is part of a six-year project funded by the Leopold Center for Sustainable Agriculture and the Iowa Egg Council.

Methods

Field Setup

For this experiment, eleven tile drained field plots and six lysimeters were used to determine if nitrate, phosphate, and bacteria would leach into tile water after the application of poultry manure and urea ammonium nitrate fertilizer (UAN). The field plots and lysimeters are located within Field 5 at the Iowa State University Agronomy and Agricultural Engineering Research Center just west of Ames, Iowa.

Field Plots.

The field plots are small fields, 0.2 to 0.4 ha (0.5 to 1.0 acres) in area, which have tile drains installed 1.2 m (4 ft) deep beneath them. The field plots are arranged so that one tile drain runs the length of each plot. At the end of each plot, in the direction of tile flow for that plot, is a

subsurface drainage sump. The tile drain goes through the sump so that tile water flow can be monitored and water samples can be collected.

From northwest to southeast, the tile plots run in order as follows: 1, 2, 3, 4, 5, 9, 6 and 10, Check plot, 7, and 8. The plots numbering 6 and 10 are adjacent to each other between plots 9 and Check plot; and the Check plot is a control plot, where no treatments are applied (Figure 1).

Lysimeters.

The lysimeters used in this experiment consist of a soil profile held within a box structure, and having a sump and tile drain apparatus set up within the soil mass (Figure 2). The lysimeter box is made up of three layers: an outer made of polyethylene plastic sheets, a middle layer made of Styrofoam sheets, and an inner layer consisting of a thick impermeable plastic liner. All these layers help to insure that water entering the lysimeter does not leak out the sides or bottom. When finished the lysimeter boxes were 152 cm (4.986 ft) high, 91.4 cm (2.998 ft) deep, and 228.6 cm (7.499 ft) wide. (Figure 2)

The lysimeters were installed in the ground, on the edge of plot 9, in two rows (three lysimeters in each row) (Figure 2). There are 3.81 m (12.499 ft) between lysimeters within each row, and 3.81 m (12.499 ft) between the two rows (Figure 3). A grave-digging machine was used to excavate individual pits to install the lysimeter boxes into the ground in. Each hole was excavated down to a depth of 1.37 m (4.49 ft). Soil from the dig was carefully separated into layers, 15 cm thick, down to a depth of 60 cm, and then 30 cm thick for the rest of the soil past the 60 cm depth. As layers were dug up and placed in a pile, the layers were kept separate from each other by placing plastic sheets between them.

When the lysimeter boxes were securely in the ground, the sump and tile drain system, made of PVC pipe, was installed (Figure 2). Once the sump and tile drain were in place, the 15 and 30 cm soil layers were packed into the lysimeter in reverse order from that in which they were dug up. This helped to make the lysimeter's soil profile match as closely to the original soil profile as possible. For a more detailed description of the lysimeter construction, read Blanket (1996.)

Treatments

All the treatments, used in this research were based on nitrogen requirements.

Field Plots.

There were three treatments applied to the field plots. Field plots 4, 6, 8, and 9 received a UAN treatment of 168 kg of N/ ha (150 lbs of N/ acre). Field plots 2, 5, and 10 received a poultry manure treatment of 168 kg of N/ ha (150 lbs of N/ acre). Field plots 1, 3, and 7 received a poultry manure treatment of 336 kg N/ha (300 lbs of N/acre). The Check plot, acting as a control, received no nitrogen treatment.

After treatments were applied, the fields were tilled and seed was planted. [Field activity dates can be found in Table 2.] On each field plot, corn was planted on one half and soybeans were planted on the other half. The nitrogen treatments were only applied to the corn half of the plots, and the corn and soybeans were rotated each year so that the corn was planted on the north side of the plots on even years and on the south side on odd years. This rotation was used to help mimic normal field conditions where corn and soybeans are planted in rotation each year.

Lysimeters.

The same three treatments, which were used on the field plots, were also applied to the lysimeters, but no lysimeters were used as a control. Lysimeters 1 and 5 received 168 kg of N/ha UAN treatment. Lysimeters 3 and 6 received 168 kg of n/ha poultry manure. Lysimeters 2 and 4 received 336 kg of N/ha poultry manure.

Preparation of the lysimeter beds, for crops, occurred on the same day as treatments were applied. [Treatment application dates can be found in Table 2]. The lysimeters' topsoil was tilled, using a shovel-spade to incorporate the UAN or poultry manure into the soil in order to make the soil loose for planting, and to till under the old corn plants from the previous growing season. Then, three shallow ditches were dug into the soil across the short length of the lysimeters, and four corn seeds in a row, 12 corn plants per lysimeter, were planted. If the seeds did not germinate for whatever reason or if it was too late in the growing season to plant seeds, corn plants from the adjacent field were transplanted into the lysimeters to make up the difference so that each lysimeter would have 12 corn plants total.

Soil Samples

Soil core samples were taken at the beginning of the each growing season, before manure/fertilizer treatments were applied to the plots/lysimeters. They were also taken at the end of the growing season after harvest. The cores measured 48 inches long, 1 ½ inches wide and were cut into the following sections starting from the soil surface down: 0-15 cm (0-6 inches), 15-30 cm (6-12 inches), 30-61 cm (12-24 inches), 61-91 cm (24-36 inches), and 91-120 cm (36-48 inches). Three soil cores were collected per field plot and the different profile sections for a plot were mixed together for a representative sample of the whole field plot. The representative samples were then bagged, and taken over to the Soil Testing Lab in the Agronomy building at Iowa State University for analysis of nitrate and phosphorus. For the lysimeters, only one soil core per lysimeter was taken and tested.

Flow Rate and Water Sampling

Field Plots.

A flow meter inside each field plot's subsurface drainage sump measures the amount of water flowing through the tile drain. The readings on the flow meters are recorded and used to determine how much water flowed through the tile drain each week. For every gallon or cubic meter of water that flows through the tile drain, a small fraction is sampled and stored in a collection bottle. From this bottle, water samples for nitrate and phosphorus are collected. If water is flowing through the tile drain, at the time of sampling, a grab sample for bacteria is obtained directly from the tile line in the sump.

Lysimeters.

In order to obtain water samples from the lysimeters, the water must be pumped out. This is accomplished by lowering a pump apparatus down into the bottom of the lysimeter's sump, and using a calibrated five-gallon bucket to catch the water as it comes up out of the outflow pump hose. The water is allowed to flow into the bucket for a few seconds before taking a bacteria water sample and nitrate/phosphorus samples. The bacteria samples are collected in a whirl-pak bag and two water samples for nitrate and phosphorous are collected in 125 mL plastic

bottles. The water in the lysimeter's sump is pumped until no more water can be obtained. Then the number of gallons of water that were pumped out is recorded and the water pumped is disposed of outside the lysimeter. This sample collecting procedure is done for each lysimeter.

Testing Water Samples

After collecting the water samples, they are taken to the Water Quality Laboratory of the Agricultural and Biosystems Engineering Department at Iowa State University for testing.

Nitrate and Phosphorus Testing.

One of the 125 mL bottle samples, from each set of two, is acidified using 2 drops of sulfuric acid. Then all the water samples are stored in a cooler (at 4° C). Later, the two water samples are used to test for nitrate, orthophosphate, and total phosphate. The nitrate, total phosphorus, and ortho-phosphorus are recorded in mg/L.

Bacteria Testing.

The bacteria water samples must be tested within 24 hours of the waters collection or else the bacteria numbers will have changed too significantly from the original concentration to be of value. Three dilutions of each sample are cultured and then incubated for 24 hours. Afterwards, the cultures are examined for total coliform and E. coli bacteria. Bacteria concentrations are recorded in colony forming units per mL of water.

Bacteria standards within the US for primary contact water (swimming) and secondary contact water (boating, fishing, etc.) are as follows:

Desirable Limit of CFU/100 mL water.

	Total Coliform	Fecal Coliform	E. coli	Fecal Streptococcus
Primary Contact Water (swimming)	<1000	<200	235	33
Secondary Contact Water (boating, fishing, etc.)	<5000	1800	---	---

*For drinking water the limits are 0 CFU/100 mL for all bacteria mentioned.

Grain Yields and Grain Quality

When the corn and soybeans are harvested in the fall, a sample from each field plot and all the corn from the lysimeters are taken to determine yield and to test for grain quality. The total sample from each field plot and lysimeter plot is weighed to calculate the yields. Then the samples are taken to a lab to be analyzed for percent oil, protein, and starch for the corn and percent oil and protein for the soybeans.

Corn stalk N

After harvest, a segment of corn stalk about 20 cm long is cut (10 cm up from the ground) from 15 random corn plants in each field plot, and from all 12 corn plants in each lysimeter. (Chinkuyu et al., 2002) The stalks are then taken to a testing laboratory where they are dried, ground, and analyzed for NO₃N (Wilhelm et al., 2000). The corn stalk N values are analyzed as both individual field plots/lysimeters and as treatment averages. These numbers are then compared to the Iowa State University Extension scale to determine if enough nitrogen was available to the corn in the latter part of its growth and fruit production. If there was not enough nitrogen available, the corn will have removed nitrogen from its lower stalk to compensate, which will result in low nitrogen levels in the stalk. The scale is as follows: excessive N levels are >2.0 g NO₃-N/kg; optimal N levels are between 0.7 and 2.0 g NO₃-N/kg; marginal levels are between 0.25 and 0.7 g NO₃-N/kg, and low N levels are less than 0.25 g NO₃-N/kg. (Blackmer et al., 1994)

Statistical Analysis

The data obtained for the first three years of this research were analyzed using SAS (1985). In general, analysis of variance was used to analyze the data, with an F-test performed for significance on the following variables: "average NO₃-N and PO₄-P concentrations and losses, amount of subsurface drain flow, grain quality parameters (oil, starch, protein), stalk N, and yields. ... If the F-tests were found to be significant, then the ordinary t-tests were conducted to find significant differences between two treatment means for every pair of treatment means. If the F-tests were not found to be significant, then no t-tests were performed, and the treatments were regarded as indistinguishable." (Chinkuyu et al., 2002) For results obtained from research conducted after the initial three years, the same statistical methods will be used to analyze the data.

Results

The data used in this report is from 1998 through 2001. Data for 2002 is still being collected.

Yields.

The average corn yields of each treatment type for both field plots and lysimeter plots show an increase in yields from treatment 0 kg N/ha to treatment 168 kg N/ha UAN to treatment 168 kg N/ha poultry manure to treatment 336 kg N/ha poultry manure. The soybean yields also expressed this same trend but this difference in treatments may not be significant. (Table 3)

Grain Quality.

The grain quality parameters (oil, protein, and starch) did not vary much from treatment to treatment for both corn and soybeans. This suggests that factors other than the treatments applied affect the grain quality of crops. (Table 4.)

Corn Stalk N.

The nitrogen levels in the corn stalks increased from treatment no application, to UAN, to low poultry manure, to high poultry manure for the field plots. (Table 4) Corn stalk N amounts

indicated that the check plot had low N levels (<250ppm), the UAN treatment had marginal N levels (250 to 700 ppm), the 150 lbs N poultry manure treatment had optimal N levels (700 to 2000 ppm), and the 300 lbs N/ac poultry manure treatment had excessive N levels (>2000 ppm).

The corn stalk N levels in the lysimeters were somewhat different than the field plots. The high poultry manure lysimeter plots did exhibit the highest corn stalk N concentrations, however, the UAN lysimeter plots on average had higher stalk N than the low poultry manure lysimeter plots.

Soil Nutrient Profile.

Nitrate.

The average nitrate levels in both field plots and lysimeters in the spring before treatment applications ranged from 15 to 22 ppm in the upper 0-15 cm of the soil. The concentration then makes a somewhat steep decline to about 1 to 4 ppm in the bottom 91-120 cm depth of the soil profile. (Table 5 and 5a) (Figures 4 & 6) After harvest in the fall, the nitrate levels decreased to between 6 and 17 ppm in the upper 0-15 cm of soil, and made a gradual decline in concentration to between 0.25 and 3.06 ppm. (Table 5 and 5a) (Figure 5 & 7) This suggests that the nitrate present in the soil, before applications, is also used by the growing crops throughout the growing season as well as being leached down further into the soil profile and washed away off the surface in runoff. In the winter nitrate levels increased again possibly due to lack of utilization by crops in combination with breakdown of crop residues left on the fields making more nitrate available.

Phosphorus.

The orthophosphorus levels in the soil increased from the time the soil samples are taken in the spring through the time the soil samples are taken in the fall after harvest for both the high and low poultry manure treatments. (Table 6) (Figures 8 through 11) This suggests that while the crops are taking up the nutrient throughout the growing season, more phosphorus is being applied than the crops can utilize.

Tile Flow and Runoff.

On average the tile flow for the low manure treatments for both field plots and lysimeters were both lower than that for the UAN treatments and high poultry manure treatments. (Table 7 and Table 9) On the other hand, the runoff in the low manure field plots was great than the runoff in the high poultry manure plots. (Table 8)

Nitrate

Subsurface.

On average nitrate concentrations and loss in tile water for poultry manure was less than that of both the UAN and high poultry manure treatments. (Table 7 and 9)

Runoff.

For runoff, there was no significant difference between high and low manure treatment effects on nitrate concentrations and loss. (Table 8)

Phosphorus.

Subsurface.

The average phosphorus concentrations and loss in tile water for poultry manure was less than that of both the UAN and high poultry manure treatments. (Table 10 and 12)

Runoff.

The high manure treatment had a significantly higher phosphorus concentration and loss averages in runoff than the low manure treatment. (Table 11)

Bacteria.

Fecal Coliform.

Subsurface. The high manure treatment's fecal coliform levels in the tile water exceeded desirable levels. On average, the low manure treatment for the field plots experienced the lower fecal coliform levels than the UAN and high manure treatments. However, the low manure treatment for the lysimeters experienced higher fecal coliform levels than the UAN treatment. (Table 13)

Runoff. The high manure treatment's fecal coliform levels in runoff exceeded desirable levels. On average, the high manure treatment field plots experienced the higher fecal coliform levels in runoff water than the low manure treatment field plots. (Table 13)

Fecal Streptococcus.

Subsurface. All of the treatments appear to have fecal streptococcus levels in tile water that exceed desirable levels. More research may need to be conducted to verify this. On average, the low manure treatment for the field plots experienced the lower fecal streptococcus levels than the UAN and high manure treatments. However, the low manure treatment for the lysimeters experienced higher fecal streptococcus levels than the UAN treatment. (Table 14)

Runoff. Both the high and low manure treatments experienced fecal streptococcus levels in runoff that exceeded the desirable levels. On average, the high manure treatment field plots experienced the higher fecal streptococcus levels in runoff water than the low manure treatment field plots. (Table 14)

E. coli.

Subsurface. The high manure treatment's E. coli levels in the tile water exceeded desirable levels. On average, the high poultry manure field plots and lysimeters experienced the highest levels of E. coli in tile water followed by the low poultry manure treatments, then the UAN treatments, and finally the field plot that received no treatment. (Table 15)

Runoff. The high manure treatment's E. coli levels in the runoff exceeded desirable levels. On average, the high manure treatment field plots experienced the higher E. coli levels in runoff water than the low manure treatment field plots. (Table 15)

Total Coliform.

Subsurface. On average, the UAN treatment experienced the lowest total coliform levels in tile water for both the field plots and the lysimeter plots. (Table 16)

Runoff. At this point there has not been any runoff during in the year 2001 when total coliform was first being tested for. (Table16)

Conclusion

It can be concluded, thus far, that the 150 lb N/ac poultry manure treatment is the best application treatment of those that were tested in this experiment. It produced higher yields than the 150 lb N/ac UAN treatment and the Check treatment (no application), while producing less nutrient contamination in tile water than the 300 lb N/ac poultry manure treatment and 150 lbs N/ac UAN treatment.

Acknowledgements

I would first like to thank the Leopold Center for Sustainable Agriculture and the Iowa Egg Council for funding this project, without which this project could not be possible. I would also like to thank all the many professors and research staff who contributed to this project and have helped it to go forward. I would like to thank Lu, Caroline, Kevin, John, Loren and the other the Water Quality Lab staff for their tireless efforts in the lab helping to analyze water samples. And I would also like to thank my major professor Dr. Kanwar, for allowing me to work on this project with him.

References

Blackmer, A.M. and A.P. Mallarino. 1994. Cornstalk testing to evaluate nitrogen management. (PM-1584.ia) Iowa State University, University Extension, Ames, Iowa.

Blanchet, Lisa Marie. 1996. Impact of lime application in transport of nitrate-nitrogen, atrazine, and cyanazine to subsurface drainage water: A field lysimeter study. Iowa State University. Ames, Iowa.

Chinkuyu, A.J., R.S. Kanwar, J.C. Lorimor, H.Xin, T.B. Bailey. Effects of laying hen manure application rate on water quality. 2002. Trans. of ASAE 45(2):299-308.

Health Council of the Netherlands (HCN). 2001. Microbial Risk of Recreational water. The Hague: Health Council of the Netherlands. Publication no. 2001/25E.

Iowa Egg Council. 2002. Egg Industry Facts.

<http://www.iowaegg.org/lowaEggIndustry/Egg-Industry.asp> 8515 Douglas Ave., Suite 9, Urbandale, Iowa 50322-2929.

Millipore. 1992. Water Microbiology Laboratory and Field Procedures. Bedford, Massachusetts.

SAS. 1985. *SAS User's Guide*. Statistics Version 8.1. Cary, N.C.: SAS Institute, Inc.

Vanlauwe, B., K. Aihou, S. Aman, E.N.O. Iwuafor, B.K. Tossah, J. Deals, N. Janginga, O. Lyasse, R. Merckx, and J. Deckers. 2001. Maize yields affected by organic inputs and urea in the West African moist savanna. *Agronomy Journal* 93:1191-1199.

Wilhelm, Wallace W., S.C. Arnold, and Jones S. Screpers. 2000. Using a nitrate specific ion electrode to determine stalk nitrate-nitrogen concentration. *Agronomy Journal* 92:186-189.

Appendix

Figures and tables on next pages.

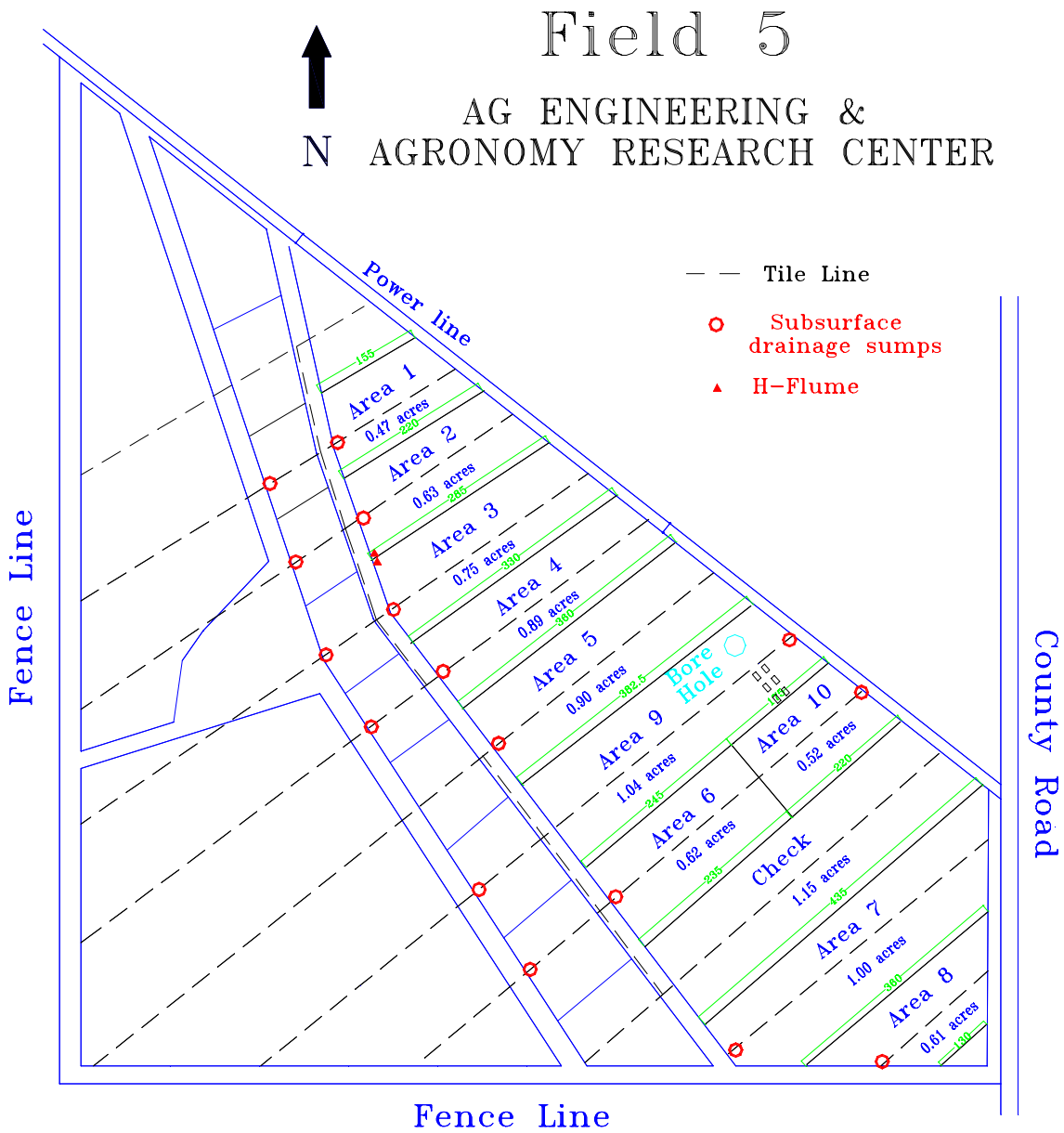

1	336 kg-N/ha	Poultry Manure	6	168 kg-N/ha	UAN Fertilizer
2	168kg-N/ha	Poultry Manure	7	336 kg-N/ha	Poultry Manure
3	336 kg-N/ha	Poultry Manure	8	168 kg-N/ha	UAN Fertilizer
4	168 kg-N/ha	UAN Fertilizer	9	168 kg-N/ha	UAN Fertilizer
5	168 kg-N/ha	Poultry Manure	10	168 kg-N/ha	Poultry Manure
Check Plot ; No Poultry Manure or UAN Fertilizer					

Figure 1. Layout of field plots to study the effects of N management systems on surface runoff and subsurface drainage water quality.

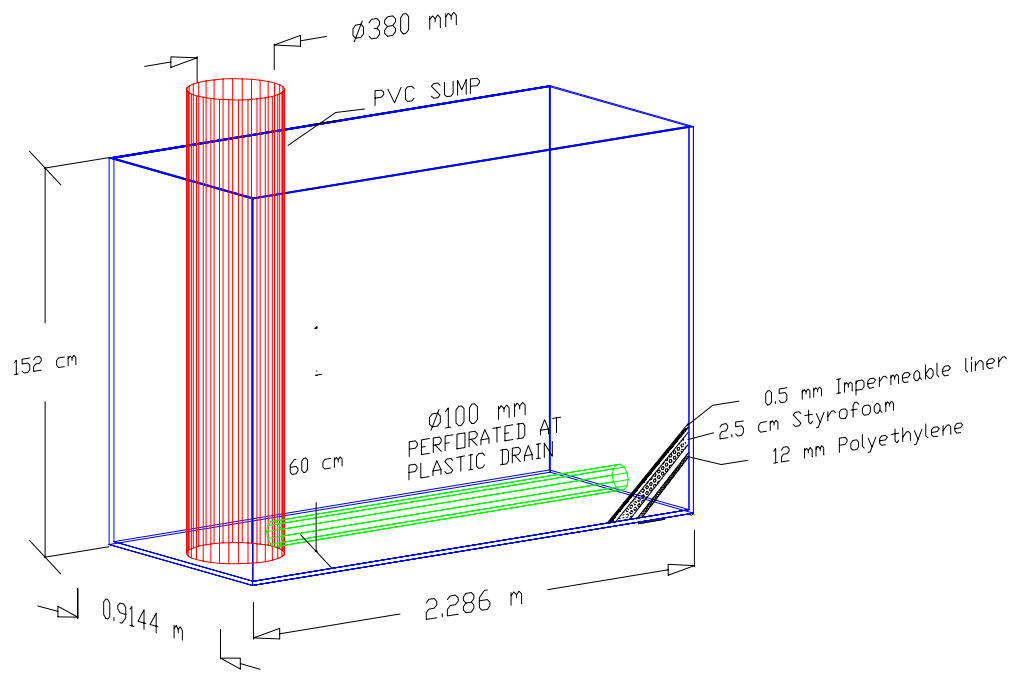

Figure 2. Design details of lysimeter construction box to study the effects of N management systems on subsurface drainage water quality.

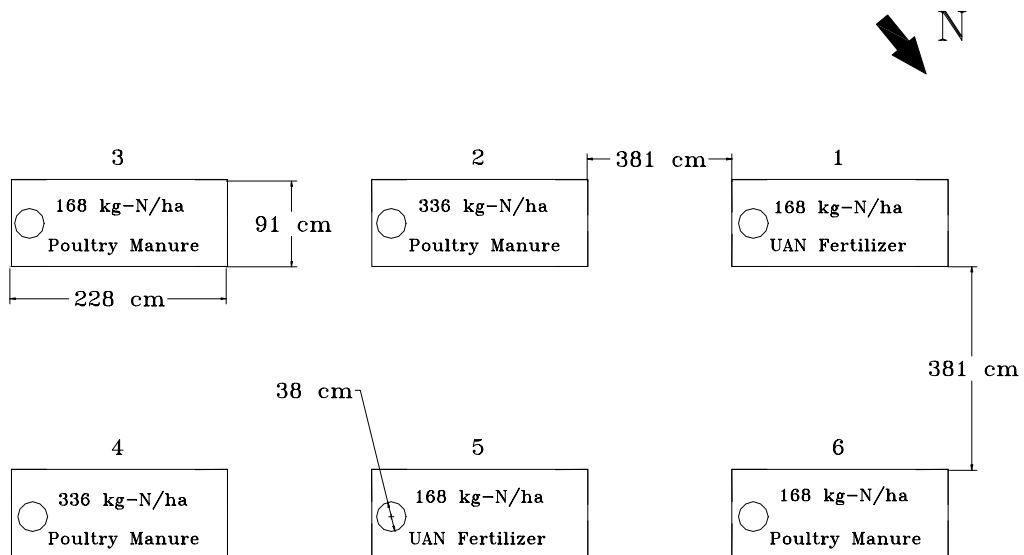

Figure 3. Layout of lysimeters to study the effects of N management systems on subsurface drainage water quality.

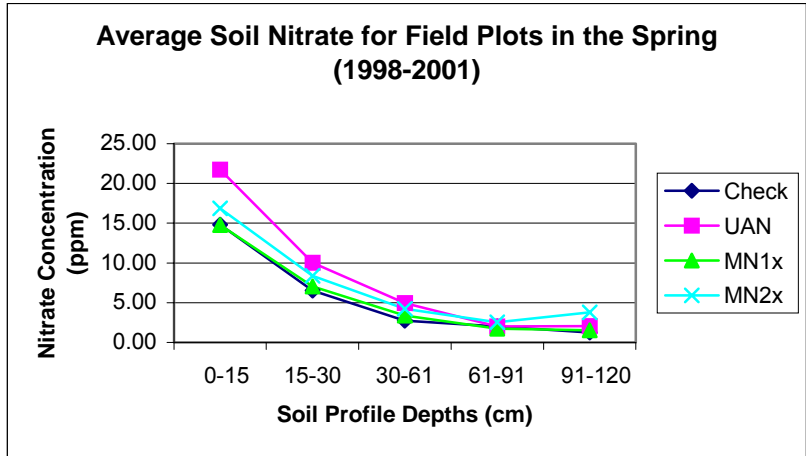

Figure 4.

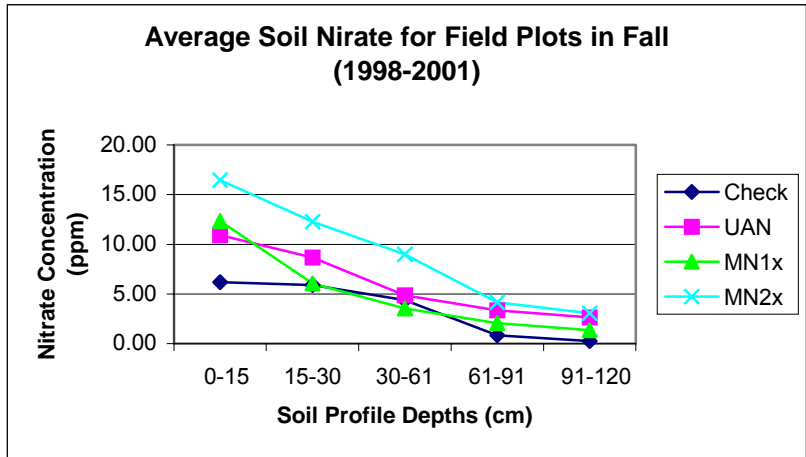

Figure 5.

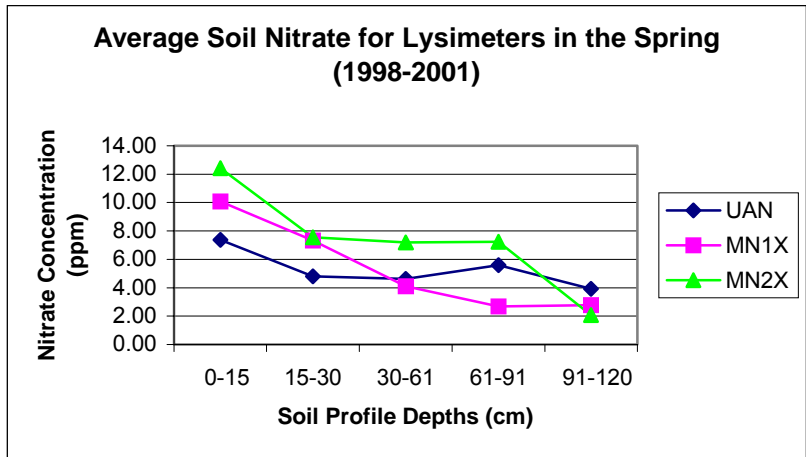

Figure 6.

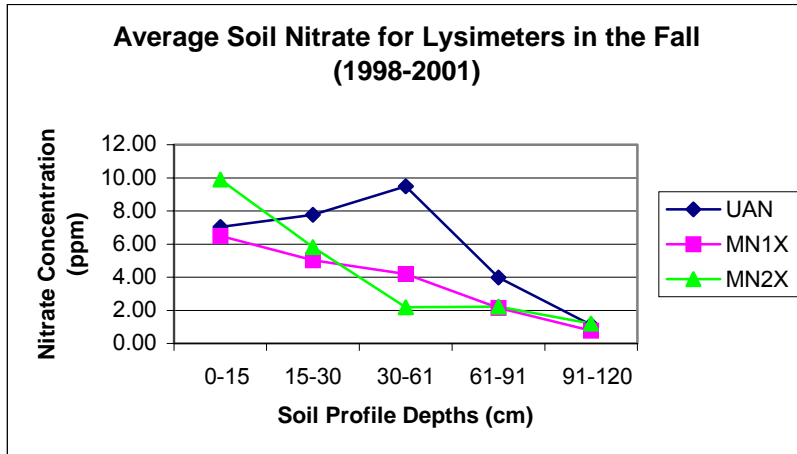

Figure 7.

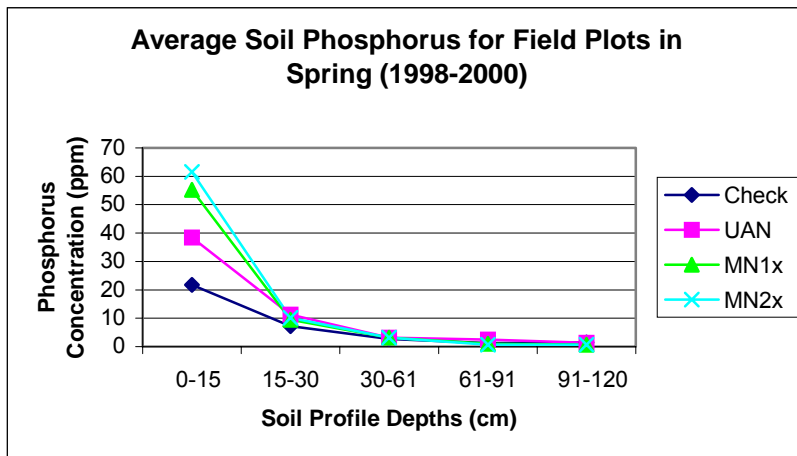

Figure 8.

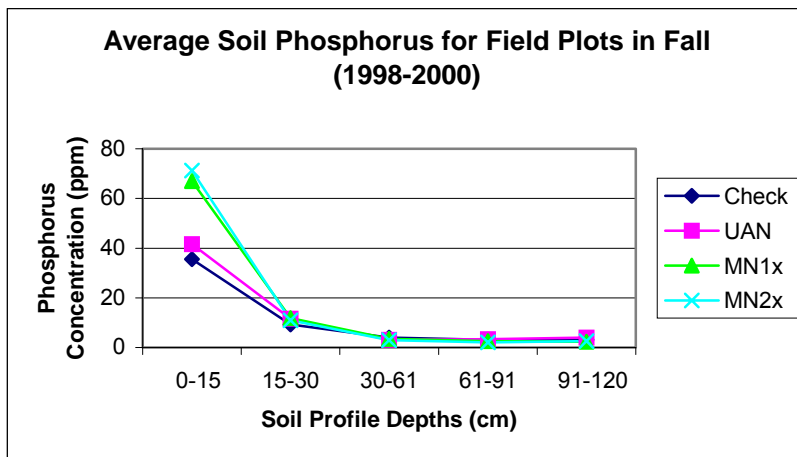

Figure 9.

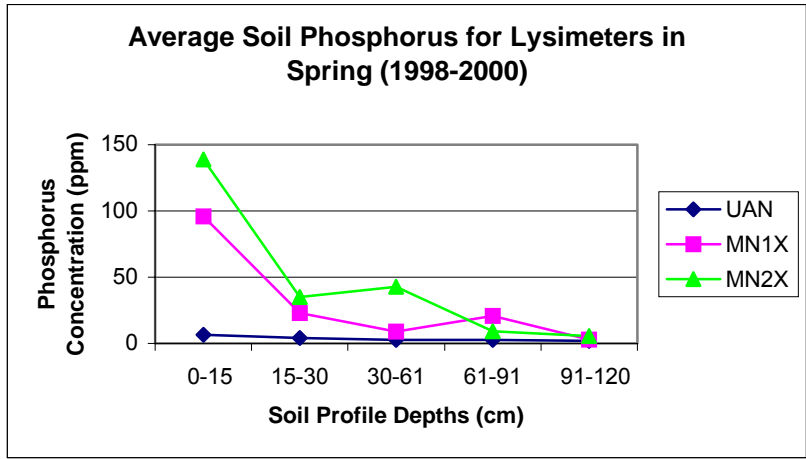

Figure 10.

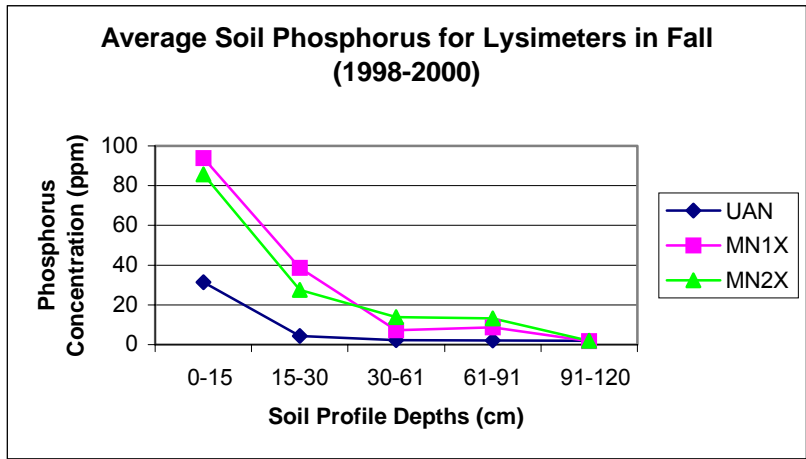

Figure 11.

Table 1. Characteristics of the laying hen manure applied during the study period.

Characteristics	Nitrogen treatments for five years									
	MN1X					MN2X				
	<u>1998</u>	<u>1999</u>	<u>2000</u>	<u>2001</u>	<u>2002</u>	<u>1998</u>	<u>1999</u>	<u>2000</u>	<u>2001</u>	<u>2002</u>
<u>Plots:</u>										
Average manure application rate, kg/ha	10847	10337	6093	8708	9213	23613	15248	12187	16834	13755
Average N application rate, kg-N/ha* [¶]	115	219	117	188	130	254	324	324	363	194
Total Kjeldhal N (TKN), %N	1.49	2.98	2.68	2.16	1.41	1.51	2.98	3.73	2.16	1.41
Ammonia (NH ₃), %N	1.11	0.74	0.72	1.64	0.57	0.52	0.82	0.78	1.64	0.57
Total Phosphorus, % P	1	4.37	3.94	2.72	2.24	0.94	4.21	3.76	2.72	2.24
Potassium, %K	1.43	2.29	2.41	2.02	1.2	1.25	1.86	2.25	2.02	1.2
Moisture content, %	48	45	33	56.97	53.7	47	55	32	56.97	53.7
<u>Lysimeters:</u>										
Average manure application rate, kg/ha	15714	7952	6000	10459	9425	31714	15905	12000	20919	18850
Average N application rate, kg-N/ha [¶]	167	169	162	636	100	337	338	325	1272	200
Total Kjeldhal nitrogen (TKN), %N	1.49	2.98	3.8	6.08	1.06	1.49	2.98	3.8	6.08	1.06
Ammonia (NH ₃), %N	1.11	0.82	0.66	1.32	0.45	1.11	0.82	0.66	1.32	0.45
Total Phosphorus, % P	1	4.21	3.73	2.1	3.29	1	4.21	3.73	2.1	3.29
Potassium, %K	1.43	1.86	2.37	1.28	1.43	1.43	1.86	2.37	1.28	1.43
Moisture content, %	48	55	28	56.9	58.2	48	55	28	56.9	58.2

* Assumed 5% N lost during application; 75% N available during the first year. In subsequent years no credit was given for residual N from the manure or N from soybeans.

[¶] Intended N application rates from layer manure were 168 kg-N/ha and 336 kg-N/ha, however, actual N application rates averaged MN1X = 150 kg-N/ha and MN2X = 300 kg-N/ha for the plots; MN1X = 166 kg-N/ha and MN2X = 333 kg-N/ha for the lysimeters.

Table 2. Dates of field activities in plots and lysimeters in 1998, 1999, 2000, 2001, and 2002.

Activity	Field plots					Field lysimeters				
	<u>1998</u>	<u>1999</u>	<u>2000</u>	<u>2001</u>	<u>2002</u>	<u>1998</u>	<u>1999</u>	<u>2000</u>	<u>2001</u>	<u>2002</u>
Fertilizer/manure application	1-May	4-May	13-Apr	17-May	3-May	20-May	5-May	14-Apr	25-Jun	22-May
Incorporating manure	1-May	4-May	13-Apr	17-May	3-May	20-May	5-May	14-Apr	25-Jun	22-May
Planting corn	8-May	10-May	8-May	18-May		21-May	10-May	8-May	25-Jun	22-May
Planting soybean	8-May	10-May	8-May	18-May		-	-	-	-	-
Cultivating in corn plots	23-Jun	16-Jun	13-Jun	21-Jun		20-Jun	29-Jun	13-Jun	-	
Cultivating in soybean plots	9-Jul	28-Jun	13-Jun	19-Jun		-	-	-	-	-
Harvesting soybeans	28 Sept.	12 Oct.	20 Sept.	17-Oct		-	-	-	-	-
Harvesting corn	19 Oct.	14 Oct.	20 Sept.	30-Oct		5 Oct.	12 Oct.	21 Sept.	18-Oct	
Cutting stalks	25 Oct.	18 Oct.	-	19-Nov		-	-	-	18-Oct	
Chisel plowing/ primary tillage	6 Nov.	12 Nov.	-	19-Nov		20-May	5-May	-	-	

Table 3. Corn and soybean yields from plots and lysimeters under different N treatments during the study period.

Year	Nitrogen treatments			
	Check plot#	UAN1X	MN1X	MN2X
	----- kg/ha -----			
<u>Corn from plots:</u>				
1998	4085c*	8414b	9448a	9138a
1999	5460c	9131b	10479a	10636a
2000	6548c	8754b	10115a	10058a
2001	6186	8079	9115	9348
Four-year average	5569.75	8594.5	9789.25	9795
<u>Soybean from plots:</u>				
1998	3567a	4083a	3966a	4303a
1999	3526a	3652a	3930a	3975a
2000	2333c	2778b	3355a	3372a
2001	2497	2763	3131	3304
Four-year average	2980.75	3319	3595.5	3738.5
<u>Corn from lysimeters:</u>				
1998	-□	3798c	5460b	9790a
1999	-	7450b	8603a	10003a
2000	-	5989b	7003b	9967a
2001	-	1475	3053	5449
Four-year average	-	4678	6029.75	8802.25

Check plot: 0 kg-N/ha; UAN1X: 168 kg-N/ha from UAN fertilizer; MN1X: 168 kg-N/ha from poultry manure; MN2X: 336 kg-N/ha from poultry manure.

* Values in the same row followed by the same letter are not significantly different at significance level of P = 0.05. □ – means no data.

Table 4. Concentration of N in cornstalks, and quality of corn and soybean grains from plots and lysimeters under different N treatments.

	Plot experiment				Lysimeter experiment		
	CHECK#	UAN1X	MN1X	MN2X	UAN1X	MN1X	MN2X
<u>Stalk N</u>	----- ppm -----						
1998	38	186	763	3299	19	9	100
1999	15	784	2686	3895	5	6	13
2000	43	2035	2723	12725	56	20	498
2001	20	1290	1123	3590	78	105	227
4-yr Avg.	29	1073.75	1823.75	5877.25	39.5	35	209.5
<u>Protein</u>	----- % -----						
1998	5.6	7	6.7	7.3	9.1	7.8	8.6
1999	6.3	7.1	7.3	7.6	6.6	5.6	7
2000	7.6	8.7	8.4	8.6	8.8	7	8.1
2001	6.8	7.1	7	7.3	16.6	17.8	19.3
4-yr Avg.	6.575	7.475	7.35	7.7	10.275	9.55	10.75
<u>Starch</u>	----- % -----						
1998	62	61.7	61.7	61.4	61.1	61.7	61.3
1999	62.4	61.7	61.3	61.3	62.3	63	62
2000	61	60	60.6	60.3	60.4	61.5	61
2001	60.3	59.7	59.8	59.6	59.2	59.7	58.7
4-yr Avg.	61.425	60.775	60.85	60.65	60.75	61.475	60.75
<u>Oil</u>	----- % -----						
1998	3.5	3.3	3.5	3.5	2.9	3.2	3.1
1999	3.8	3.7	3.9	3.8	3.7	3.9	3.7
2000	2.9	3.1	3.1	3.1	2.7	2.8	2.6
2001	3.6	3.3	3.4	3.5	9.7	8.4	9.2
4-yr Avg.	3.45	3.35	3.475	3.475	4.75	4.575	6.2
<u>Soybeans</u>							
<u>Protein</u>	----- % -----						
1998	35.8	35.7	35.7	35.4			
1999	36.3	36.1	36	36			
2000	35.8	36	36.1	36.9			
2001	33.8	34.1	33.1	33			
4-yr Avg.	35.425	35.475	35.225	35.325			
<u>Oil</u>	----- % -----						
1998	18.8	18.1	18.1	18			
1999	16.4	16.3	16.4	16.3			
2000	16.2	16.2	16.1	16.6			
2001	17.9	18.5	19.1	18.7			
4-yr Avg.	17.325	17.275	17.425	17.4			

CHECK: 0 kg-N/ha; UAN1X: 168 kg-N/ha from UAN fertilizer; MN1X: 168 kg-N/ha from poultry manure; MN2X: 336 kg-N/ha from poultry manure.

* Values in the same row followed by the same letter are not significantly different at significance level of P = 0.05.

Table 5. Average NO₃-N concentrations in the soil profile in field plots and lysimeters before planting and after harvesting during the study period.

Sampling date	Depth cm	Nitrogen treatments						
		Field plots				Lysimeters		
		Check*	UAN1X	MN1X	MN2X	UAN1X	MN1X	MN2X
		----- NO ₃ -N concentration, ppm -----						

Before planting May-98	0-15	13	16.23	16.45	17.85	8.32	15.73	12.3
	15-30	3.1	5.75	6.3	6.95	8.32	15.73	12.3
	30-61	1.1	3.6	2.7	2.73	4.34	5.54	6.14
	61-91	-□	0.88	0.55	0.93	4.69	3.52	6.06
	91-120	-	-	-	-	-	8.28	-
After harvesting Oct. 1998	0-15	7.9	10	11.4	16.92	4.67	5.33	8.2
	15-30	4.9	9.16	7.09	18.48	4.35	5.71	8.71
	30-61	1.13	3.28	3.65	18.54	3.73	3.53	4.39
	61-91	1	2.26	2.6	5.78	2.94	2.95	3.89
	91-120	-	1.26	1.12	1.49	2.21	1.84	3.09
Before planting May-99	0-15	15.95	35.79	10.79	12.73	3.8	2.55	1.85
	15-30	5.46	15.74	4.86	5.38	3.15	3.35	2.85
	30-61	4.21	9.51	5.19	4.81	2.85	3.58	2.55
	61-91	4.16	4.94	4.21	3.3	3.5	3.5	3.15
	91-120	2.34	3.03	2.94	2.51	2.25	2.2	3.1
After harvesting Oct. 1999	0-15	2.3	7.95	7.67	13.3	4.75	5.55	10.5
	15-30	1.2	2.95	2.4	5.67	1.55	1.15	1.75
	30-61	1	2.23	1	6.4	0.6	1	0.6
	61-91	-	3.33	1.13	5.6	-	-	-
	91-120	-	3.3	1.57	2.87	-	-	-
Before planting May-00	0-15	16.8	19.15	17.53	22.28	14.78	18.25	28.7
	15-30	10.3	9.93	9.02	11.83	6.28	8.7	6.4
	30-61	3.55	3.51	2.92	3.87	2.8	5.45	4.35
	61-91	0.75	0.99	0.85	1.83	0.98	0.58	1.23
	91-120	0	0.67	0.5	4.4	0.8	0.1	0.1
After harvesting Oct. 2000	0-15	12	8	14	12.3	9.5	10	7.5
	15-30	17	10.3	11	14	11	8	2
	30-61	13	5.8	7	6	24.5	10.5	2
	61-91	1	5.5	4	2.5	5	3	0
	91-120	0	3.5	2	3	0	0	0

□ Check: 0 kg-N/ha; UAN1X: 168 kg-N/ha from UAN fertilizer; MN1X: 168 kg-N/ha from poultry manure; MN2X: 336 kg-N/ha from poultry manure. □ – means no data. **BDL** means below detectable levels.

Table 5a. (Continuation of Table 5.)

Sampling date	Depth cm	Nitrogen treatments						
		Field plots				Lysimeters		
		Check*	UAN1X	MN1X	MN2X	UAN1X	MN1X	MN2X
		----- NO ₃ -N concentration, ppm -----						

After harvesting Oct. 2001	0-15	2.50	17.70	16.28	23.28	9.23	5.13	13.38
	15-30	0.50	12.26	3.70	10.93	14.2	5.25	10.83
	30-61	2.45	8.10	2.52	4.95	9.15	1.75	1.75
	61-91	0.50	2.29	0.50	2.77	4	0.5	2.75
	91-120	0.50	2.56	0.67	4.87	1.15	0.5	0.5
Before planting May-02	0-15	13.5	15.73	14.28	14.57	2.63	3.8	6.83
	15-30	7.2	8.66	8.05	9.32	1.43	1.5	8.65
	30-61	2.15	3.26	2.67	5.49	8.53	1.83	15.73
	61-91	1.1	1.26	1.38	4.12	13.23	3.1	18.53
	91-120	1.4	2.5	1.17	4.43	8.75	0.5	5.08

□ Check: 0 kg-N/ha; UAN1X: 168 kg-N/ha from UAN fertilizer; MN1X: 168 kg-N/ha from poultry manure; MN2X: 336 kg-N/ha from poultry manure. □ – means no data. **BDL** means below detectable levels.

Table 6. Average PO₄-P concentrations in the soil profile in field plots and lysimeters before planting and after harvesting during the study period.

Sampling date	Depth	Nitrogen treatments						
		Field plots				Lysimeters		
		Check*	UAN1X	MN1X	MN2X	UAN1X	MN1X	MN2X
	cm	----- PO ₄ -P concentration, ppm -----						
Before planting May-98	0-15	□	-	-	-	-	-	-
	15-30	-	-	-	-	-	-	-
	30-61	-	-	-	-	-	-	-
	61-91	-	-	-	-	-	-	-
	91-120	-	-	-	-	-	-	-
After harvesting Oct. 1998	0-15	38	33.8	64.2	85.3	5.5	52	68
	15-30	11	10.3	5.3	10.2	5.5	52	68
	30-61	5.5	3.1	2.2	2	2.5	11.5	34.5
	61-91	2.7	4.9	0.8	0.7	2.5	19.5	34.5
	91-120	4.3	6.9	-	-	-	-	-
Before planting May-99	0-15	18	37.5	42.5	32.3	7.5	106	30
	15-30	6	12.1	10.5	9.2	4	36	61
	30-61	2.5	3.5	3.2	2.8	3.5	12	82
	61-91	0.5	3	1.2	0.3	4	40	17
	91-120	1	-	0.5	0.2	2	4	10
After harvesting Oct. 1999	0-15	18.5	32.9	54.8	57.7	16.5	66	87
	15-30	8	13.1	14.8	16	2.5	10.5	7.5
	30-61	3	4.1	4	4.2	1.5	3	4
	61-91	2	4.5	2.7	2.1	1.5	4	2
	91-120	0.5	4.1	3.3	2	2	1	1
Before planting May-00	0-15	25.5	39.3	68	90.7	5.5	86	248
	15-30	8.5	10.4	8.5	11.2	4	10	9
	30-61	3	2.8	3.2	3.5	2	6	3.5
	61-91	2	2	0.8	1	1.5	1.5	1.5
	91-120	2	1.4	0.8	1.2	2	2	1
After Harvesting Oct. 2000	0-15	50	58	82	70.6	72	163.5	102
	15-30	9	11.5	15.4	6.8	5	53.5	7
	30-61	3.5	1.9	4.2	2.7	3	7	3
	61-91	4.5	0.8	4.3	3.5	2.5	2.5	3
	91-120	4.5	1	1.3	3.2	2	2.5	3

□ Check: 0 kg-N/ha; UAN1X: 168 kg-N/ha from UAN fertilizer; MN1X: 168 kg-N/ha from poultry manure; MN2X: 336 kg-N/ha from poultry manure. □ – means no data.

Table 7. Monthly subsurface drain flow, NO₃-N concentrations, and losses with subsurface drain from plots under different N treatments.

Year and month		Tile flow (cm)			NO ₃ -N concentration (mg/L)			NO ₃ -N loss (kg/ha)			
		UAN1X*	MN1X	MN2X	CHECK	UAN1X	MN1X	MN2X	UAN1X	MN1X	MN2X
<u>Subsurface drain water</u>											
<u>1998</u>	Mar.	1.6	0.7	1.3	-□	17	9.2	13.7	2.6	0.7	1.6
	Apr.	1.9	3.2	5.5	-	16.3	12.6	17.8	2.8	4.5	11.2
	May	3.2	2.2	4.9	-	18.3	13.3	17.3	5.7	2.9	7.9
	June	11.5	6.5	10	-	20.8	17.5	23.8	24.3	13.7	24.7
	July	6	3.5	2.8	-	19.3	15.9	22.3	11.8	5.7	5.6
	Avg./ Annual	24.1a [†]	16.1b	24.5a	-	18.9a	14.6b	20.2a	47.1a	27.5b	51.0a
<u>1999</u>	Apr.	5.4	3.4	4.9	-	19.2	19.4	32.1	10.3	6.5	17
	May	5.2	4.1	5	-	21.9	22.9	31.4	12	9.3	15.9
	June	7.6	3.9	5	-	22.6	22.2	31.6	17.2	8.2	16.3
	July	1.3	0.6	2	-	21.5	15.6	28.7	1.4	1.1	5.5
	Aug.	0.3	0.5	0.5	-	12.4	10.9	23.7	0.7	0.6	0.9
	Avg./ Annual	19.8a	12.5b	17.4b	-	20.8b	20.3b	30.9a	41.6a	25.7b	55.7a
<u>2000</u>	May	0.7	0.1	0.2	11.4	14.6	13.6	40.3	1	0.2	0.8
	June	1.6	0.4	1.4	7.8	23.1	15.7	46.4	3.8	0.6	6.9
	July	0.02	0.03	0.1	6.7	23.5	12.1	46.3	0.1	0.01	0.2
	Avg./ Annual	2.3a	0.6a	1.6a	9.0d	21.0b	14.3c	44.1a	4.8a	0.9b	7.9a
<u>2001</u>	Mar.	0.1	0.02	0	-	-	-	-	-	-	-
	Apr.	0.5	0.2	1.4	2.7	10.4	9.8	12	0.2	0.1	0.5
	May	6.8	4.6	7.4	10.3	21.5	21.9	43.9	7.3	3.4	10.7
	June	1.9	1.5	2.7	10.2	24.8	25.5	45.4	5.5	3.4	6.5
	July	0.1	0.2	0.1	9.9	0	9.9	0	0	0.1	0
	Avg./ Annual	10.5	7.8	12.4	8.3	14.2	16.7	25.3	13.1	6.9	17.8
4-Year Average		14.2	9.3	14.0	8.7	18.7	16.5	30.2	26.7	15.3	33.1

* Check: 0 kg-N/ha; UAN1X: 168 kg-N/ha from UAN fertilizer; MN1X: 168 kg-N/ha from poultry manure; MN2X: 336 kg-N/ha from poultry manure.

[†] Mean values for each variable in the same row followed by the same letter are not significantly different at significance level of P = 0.05. □ – means no data.

Table 8. Monthly runoff, NO₃-N concentrations and losses with surface runoff water from plots under different N treatments.

Year and month		Runoff (cm)			NO ₃ -N concentration (mg/L)			NO ₃ -N loss (kg/ha)			
		UAN1X*	MN1X	MN2X	CHECK	UAN1X	MN1X	MN2X	UAN1X	MN1X	MN2X
<u>1998</u>	May	-□	0.5	0.7	-	-	13.1	13.2	-	0.6	0.9
	June	-	1.1	1.1	-	-	14.7	15.1	-	1.6	1.7
	July	-	0.7	0.7	-	-	16.3	17.5	-	1.1	1.2
	Aug.	-	0.4	0.4	-	-	11	11.7	-	0.4	0.5
	Avg./Annual	-	2.5a	2.9a	-	-	13.8a	14.4a	-	3.6a	4.3a
<u>1999</u>	June	-	2.5	1.6	-	-	5.2	7.1	-	1.3	1.1
	Aug.	-	0.3	0.2	-	-	3	4.4	-	0.1	0.1
	Avg./Annual	-	2.7a	1.8a	-	-	4.7a	6.5a	-	1.4a	1.2a
<u>2000</u>	May	-	-	-	-	-	0.6	1.8	-	-	-
	Avg./Annual	-	-	-	-	-	0.6b	1.8a	-	-	-
<u>2001</u>	Avg./Annual	-	-	-	-	-	-	-	-	-	
<u>Four-Year Average</u>		-	2.6a	2.4a	-	-	6.7a	8.0a	-	2.5a	2.8a

* Check: 0 kg-N/ha; UAN1X: 168 kg-N/ha from UAN fertilizer; MN1X: 168 kg-N/ha from poultry manure; MN2X: 336 kg-N/ha from poultry manure.

† Mean values for each variable in the same row followed by the same letter are not significantly different at significance level of P = 0.05. □ – means no data.

Table 9. Monthly subsurface drain flow, NO₃-N concentrations, and losses with subsurface drain water from lysimeters under different N treatments.

Year and month	Tile flow (cm)			NO ₃ -N concentration (mg/L)			NO ₃ -N loss (kg/ha)		
	UAN1X*	MN1X	MN2X	UAN1X	MN1X	MN2X	UAN1X	MN1X	MN2X
<u>1998</u>									
May	1.9	1.3	1.7	9	2.3	13.3	1.5	0.3	2.5
June	22.1	16.9	19.9	15.5	9.6	20.6	32.9	18.6	40.5
July	4	2.5	3	21.1	14.3	32.2	8.2	3.6	9.3
Avg./Annual	28.0a [†]	20.6b	24.6b	15.3a	8.7b	22.0a	42.6a	22.4b	52.3a
<u>1999</u>									
April	7.8	6.2	6.5	8.6	9.5	20.7	6.7	5.8	13.3
May	9.3	7.5	10.5	9.5	10.3	19.1	8.7	8.1	18.6
June	12.9	11.5	14	8.3	9.7	14.2	10.6	10.7	19.3
July	3.1	2.2	2.9	9.4	7.5	12.1	2.9	1.8	3.5
August	1.1	1.1	1.2	10.1	10	14.8	1.1	1.1	1.7
Avg./Annual	34.2a	28.5b	35.0a	9.2b	9.4b	16.2a	29.9b	27.5b	56.4a
<u>2000</u>									
May	2.4	2.7	2.6	4.4	4.3	9.3	1.1	1.1	2.4
June	4.3	4.7	6	7.3	4.3	10.7	2.9	1.9	6.4
July	0.5	0.5	0.8	9.5	4.7	11.7	0.5	0.2	0.9
Avg./Annual	7.2a	7.8a	9.3a	7.1b	4.4c	10.6a	4.5b	3.3b	9.7a
<u>2001</u>									
May	25.3	25.1	26.3	25.1	6.1	13.5	63.5	14.5	35.5
June	5.3	4.5	4.8	20.2	5	9.5	10.6	2.3	4.5
July	0.5	0.5	0.3	20.5	3.1	6.7	1	0.1	0.2
Avg./Annual	31	30.1	31.4	21.9	4.7	9.9	75.1	16.9	40.3
4-Year Avg.	25.1	21.75	25.1	13.4	6.8	22.2	28.0	17.5	39.7

* UAN1X: 168 kg-N/ha from UAN fertilizer; MN1X: 168 kg-N/ha from poultry manure; MN2X: 336 kg-N/ha from poultry manure.

[†] Mean values for each variable in the same row followed by the same letter are not significantly different at significance level of $p = 0.05$.

Table 10. Average PO₄-P concentrations and losses with subsurface drain water from plots under different N treatments.

Year and month		PO ₄ -P conc. (mg/L)				PO ₄ -P loss (kg/ha)		
		CHECK*	UAN1X	MN1X	MN2X	UAN1X	MN1X	MN2X
<u>Subsurface drain water</u>								
<u>1998</u>	Apr.	-□	0.022	0.025	0.025	0.0015	0.002	0.0042
	May	-	0.025	0.022	0.053	0.0054	0.0054	0.0138
	June	-	0.014	0.014	0.016	0.0178	0.0107	0.0099
	July	-	0.007	0.015	0.009	0.0052	0.0016	0.0019
	Avg./Annual	-	0.016b [¶]	0.016b	0.022a	0.0299a	0.0197a	0.0298a
<u>1999</u>	Apr.	-	0.012	0.009	0.019	0.0065	0.0026	0.0115
	May	-	0.017	0.014	0.033	0.0041	0.0029	0.0089
	June	-	0.021	0.014	0.035	0.0162	0.0054	0.0171
	July	-	0.014	0.017	0.101	0.0021	0.0009	0.0148
	Aug.	-	0.056	0.032	0.042	0.0014	0.001	0.0008
	Avg./Annual	-	0.019b	0.015c	0.039a	0.0302b	0.0128c	0.0531a
<u>2000</u>	May	0.029	0.01	0.04	0.259	0.0006	0.0003	0.0013
	June	0.017	0.011	0.011	0.016	0.0013	0.0004	0.0014
	July	0.011	0.01	0.014	0.014	-	-	0.0001
	Avg./Annual	0.020b	0.010c	0.024b	0.107a	0.0019a	0.0007a	0.0028a
<u>2001</u>	May	0.005	0.002	0.004	0.038	0.0005	0.0006	0.0093
	June	0.003	0.003	0.003	0.007	0.0006	0.0004	0.001
	July	0.002	0.036	0.001	0.003	0.0002	0	0
	Avg./Annual	0.003	0.013	0.003	0.016	0.0013	0.0011	0.0104
4-year avg.		0.0115	0.0145	0.0145	0.046	0.0158	0.0085	0.024

* CHECK: 0kg-N/ha; UAN1X: 168 kg-N/ha from UAN fertilizer; MN1X: 168 kg-N/ha from poultry manure; MN2X: 336 kg-N/ha from poultry manure.

[¶] Mean values for each variable in the same row followed by the same letter are not significantly different at significance level of P = 0.05. □ – means no data.

Table 11. Average PO₄-P concentrations and losses with surface runoff water from plots under different N treatments.

Year and month		PO ₄ -P conc. (mg/L)				PO ₄ -P loss (kg/ha)		
		CHECK*	UAN1X	MN1X	MN2X	UAN1X	MN1X	MN2X
<u>Runoff water:</u>								
<u>1998</u>	May	-	-	1.381	1.011	-	0.0621	0.066
	June	-	-	1.666	1.69	-	0.176	0.192
	July	-	-	1.116	1.998	-	0.075	0.131
	Aug.	-	-	0.48	0.709	-	0.017	0.03
	Avg./Annual	-	-	1.161a	1.352a	-	0.3300a	0.4190a
<u>1999</u>	June	-	-	0.802	0.997	-	0.0378	0.116
	Aug.	-	-	0.543	0.605	-	0.014	0.013
	Avg.	-	-	0.750b	0.918a	-	0.0518a	0.1290a
<u>2000</u>	May	-	-	0.4	0.663	-	-	-
	Avg./Annual	-	-	0.400a	0.663a	-	-	-
<u>2001</u>	Avg./Annual	-	-	-	-	-	-	-
4-year avg.		-	-	0.770b	0.978a	-	0.1909b	0.2740a

* CHECK: 0kg-N/ha; UAN1X: 168 kg-N/ha from UAN fertilizer; MN1X: 168 kg-N/ha from poultry manure; MN2X: 336 kg-N/ha from poultry manure.

† Mean values for each variable in the same row followed by the same letter are not significantly different at significance level of P = 0.05. □ – means no data.

Table 12. Monthly subsurface drain flow, PO₄-P concentrations and losses with subsurface drain water from lysimeters under different N treatments.

	PO ₄ -P concentration (mg/L)			PO ₄ -P loss (kg/ha)		
	UAN1X*	MN1X	MN2X	UAN1X	MN1X	MN2X
<u>1998</u>						
May	0.296	0.024	0.017	0.072	0.003	0.003
June	0.13	0.023	0.018	0.289	0.034	0.036
July	0.155	0.01	0.008	0.07	0.003	0.002
Avg./Annual	0.194a [¶]	0.020b	0.014b	0.431a	0.040b	0.040b
<u>1999</u>						
April	0.059	0.019	0.04	0.044	0.012	0.024
May	0.027	0.027	0.1	0.025	0.02	0.119
June	0.016	0.019	0.023	0.021	0.024	0.034
July	0.017	0.024	0.019	0.006	0.006	0.006
August	0.356	0.174	0.195	0.038	0.019	0.023
Avg./Annual	0.095a	0.053c	0.075b	0.133a	0.081b	0.207a
<u>2000</u>						
May	0.018	0.007	0.015	0.004	0.002	0.004
June	0.029	0.011	0.017	0.011	0.005	0.01
Avg./Annual	0.024a	0.009b	0.016b	0.015a	0.007c	0.013b
<u>2001</u>						
May	0.005	0.012	0.01	0.011	0.027	0.025
June	0.006	0.006	0.008	0.003	0.003	0.004
July	0.011	0.013	0.028	0.001	0.001	0.001
Avg./Annual	0.007	0.01	0.015	0.015	0.031	0.03
4-yr average	0.08	0.023	0.03	0.149	0.04	0.073

* UAN1X: 168 kg-N/ha from UAN fertilizer; MN1X: 168 kg-N/ha from poultry manure; MN2X: 336 kg-N/ha from poultry manure. [¶] Mean values for each variable in the same row followed by the same letter are not significantly different at significance level of p = 0.05.

Table 13. Average concentrations of fecal coliform in subsurface drain and runoff water from plots and lysimeters under different N treatments.

	Type of experiment and nitrogen treatment						
	Field plot experiment				Lysimeter experiment		
	Check [#]	UAN1X	MN1X	MN2X	UAN1X	MN1X	MN2X
<u>Subsurface water</u>	-----cfu/100 mL -----						
1998	0	12b*	10b	1419a	112b	48c	513a
1999	0	44b	46b	1036a	145c	394b	657a
2000	68b	79b	32b	334a	12c	458a	213b
2001	-	-	-	-	-	-	-
4-year average	68b	45b	29b	929a	123b	353a	521a
<u>Surface runoff</u>							
1998 mean	-	-	-	-	-	-	-
5/12/1999	-‡	-	0	85a	-	-	-
5/19/1999	-	-	10	427a	-	-	-
6/1/1999	-	-	0	1990a	-	-	-
Mean	-	-	10b	834a	-	-	-
6/5/2000	-	-	0	100a	-	-	-
Mean	-	-	0	100a	-	-	-
2001 mean	-	-	-	-	-	-	-
5-year average	-	-	10b	467a	-	-	-

CHECK: 0kg-N/ha; UAN1X: 168 kg-N/ha from UAN fertilizer; MN1X: 168 kg-N/ha from poultry manure; MN2X: 336 kg-N/ha from poultry manure. * Values in the same row followed by the same letter, in each experiment, are not significantly different at significance level of P = 0.05. ‡ - no data.

Table 14. Average concentration of fecal streptococcus bacteria in surface runoff and subsurface drain water from plots and lysimeters under different N treatments.

	Type of experiment and nitrogen treatment						
	Field plot experiment				Lysimeter experiment		
	Check [#]	UAN1X	MN1X	MN2X	UAN1X	MN1X	MN2X
<u>Subsurface water</u>	-----cfu/100 mL -----						
1998	0	48b*	70b	345a	149c	422b	881a
1999	0	63b	68b	714a	153b	501a	470a
2000	67b	112a	30b	161a	216a	115b	97b
2001	-	-	-	-	-	-	-
Four-year average	67b	74b	56b	407a	165b	417a	498a
<u>Surface runoff</u>							
1998 mean	-	-	-	-	-	-	-
5/19/1999	- ‡	-	100	339	-	-	-
6/1/1999	-	-	170	1585	-	-	-
Average	-	-	135b	962a	-	-	-
6/5/2000	-	-	20	215	-	-	-
Average	-	-	20b	215a	-	-	-
2001 mean	-	-	-	-	-	-	-
Four-year average	-	-	78b	589a	-	-	-

[#] CHECK: 0kg-N/ha; UAN1X: 168 kg-N/ha from UAN fertilizer; MN1X: 168 kg-N/ha from poultry manure; MN2X: 336 kg-N/ha from poultry manure. * Values in the same row followed by the same letter, in each experiment, are not significantly different at significance level of P = 0.05. ‡ - no data.

Table 15. Average Concentration of E. coli bacteria in surface runoff and subsurface drain water from plots and lysimeters under different N treatments.

	Type of experiment and nitrogen treatment						
	Field plot experiment				Lysimeter experiment		
	Check [#]	UAN1X	MN1X	MN2X	UAN1X	MN1X	MN2X
<u>Subsurface water</u>	-----cfu/100 mL -----						
1998	0	8b*	36b	1167a	62c	685b	1067a
1999	0	33b	62b	545a	91b	217a	273a
2000	21a	61c	57a	83a	30b	16b	208a
2001	30	6	23	220	0	1	0
Four-year average	13	27	45	504	46	230	387
<u>Surface runoff</u>							
1998 mean	-	-	-	-	-	-	-
5/12/1999	-‡	-	10	0	-	-	-
5/19/1999	-	-	208	365	-	-	-
6/1/1999	-	-	100	231	-	-	-
Average	-	-	106a	298a	-	-	-
6/5/2000	-	-	0	2300	-	-	-
Average	-	-	0	2300a	-	-	-
2001 mean	-	-	-	-	-	-	-
Four-year average	-	-	106b	1299a	-	-	-

[#] CHECK: 0kg-N/ha; UAN1X: 168 kg-N/ha from UAN fertilizer; MN1X: 168 kg-N/ha from poultry manure; MN2X: 336 kg-N/ha from poultry manure. * Values in the same row followed by the same letter, in each experiment, are not significantly different at significance level of p = 0.05. ‡ - means no data.

Table 16. Average concentrations of total coliform in subsurface drain and runoff water from plots and lysimeters under different N treatments

	Type of experiment and nitrogen treatment						
	Field plot experiment				Lysimeter experiment		
	Check#	UAN1X	MN1X	MN2X	UAN1X	MN1X	MN2X
<u>Subsurface water</u>	-----cfu/100 mL -----						
<u>1998</u>	-	-	-	-	-	-	-
<u>1999</u>	-	-	-	-	-	-	-
<u>2000</u>	-	-	-	-	-	-	-
<u>2001</u>	151	76	170	273	143	146	428
<u>4-Year Avg.</u>	151	76	170	273	143	146	428
<u>Runoff</u>							
<u>1998</u>	-	-	-	-	-	-	-
<u>1999</u>	-	-	-	-	-	-	-
<u>2000</u>	-	-	-	-	-	-	-
<u>2001</u>	-	-	-	-	-	-	-
<u>4-Year Avg.</u>	-	-	-	-	-	-	-

CHECK: 0kg-N/ha; UAN1X: 168 kg-N/ha from UAN fertilizer; MN1X: 168 kg-N/ha from poultry manure; MN2X: 336 kg-N/ha from poultry manure. * Values in the same row followed by the same letter, in each experiment, are not significantly different at significance level of P = 0.05. ‡ - no data.